

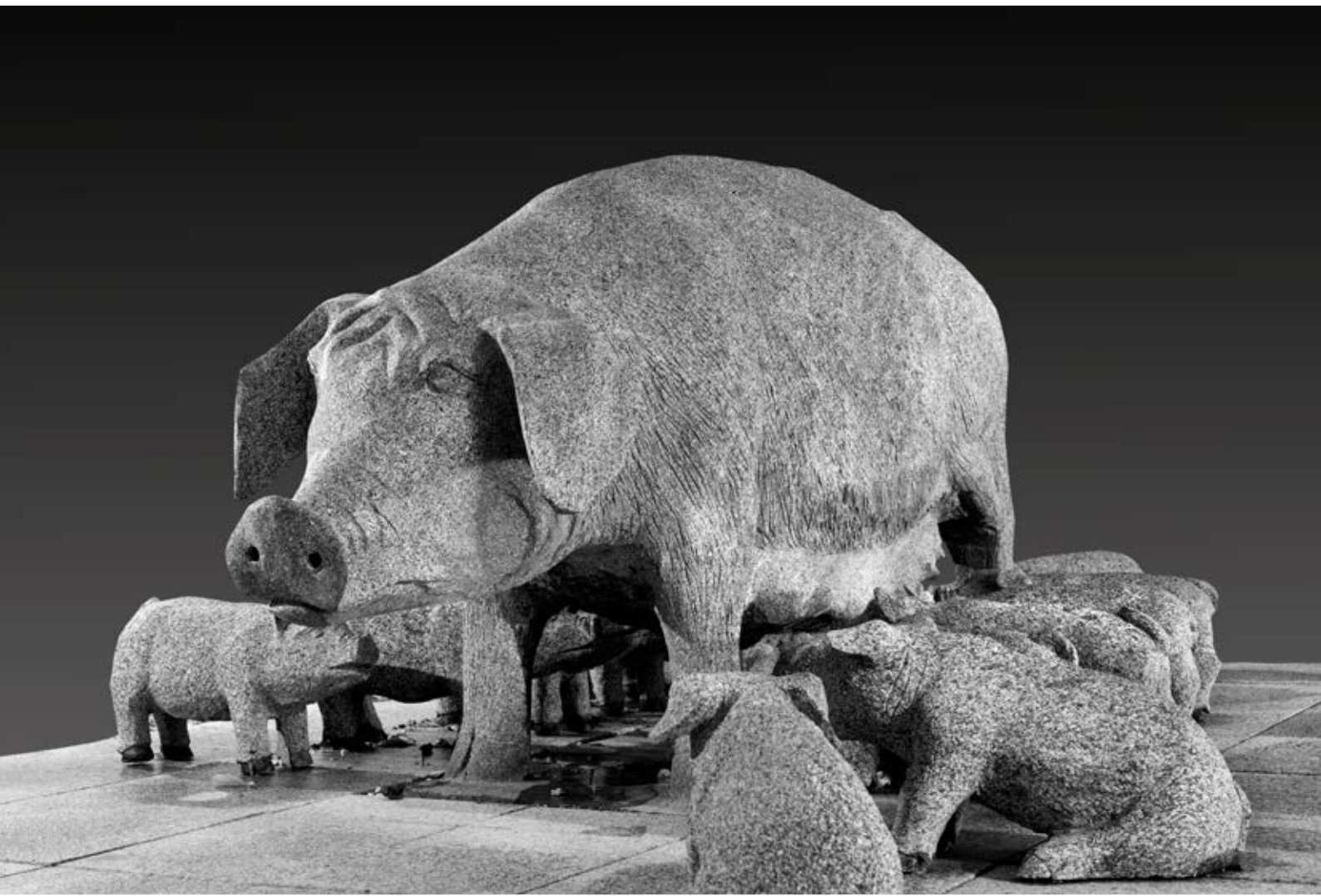

ACO FUNKI

INTELLIGENT FARM SOLUTIONS



DANISH DESIGN | GERMAN QUALITY | GLOBAL EXPERIENCE

WELCOME TO ACO FUNKI



Your partner for the next project

ACO FUNKI A/S is one of the leading European suppliers of livestock equipment for pig producers worldwide. We develop and produce a complete range of products for new or existing farms, including penning equipment, intelligent feeding systems, flooring, water systems, components, and spare parts.

We focus on the technologies aiming to reduce feed waste, minimize impact on the environment and at the same time provide the best possible conditions for animals.

**“ WE MAKE SUSTAINABLE
PIG PRODUCTION POSSIBLE
WITH INTELLIGENT FARM SOLUTIONS ”**

HQ - DENMARK

ACO Funki A/S

Kirkevænget 5, 7400 Herning

+45 97 11 96 00

acofunki@acofunki.dk

www.acofunki.com

FRANCE

info.fr@acofunki.com

www.acofunki.fr

SPAIN

fclosa@acofunki.com

www.acofunki.es

GERMANY

info@aco-funki.de

www.acofunki.de

CHINA

acofunki@acofunki.cn

www.acofunki.cn

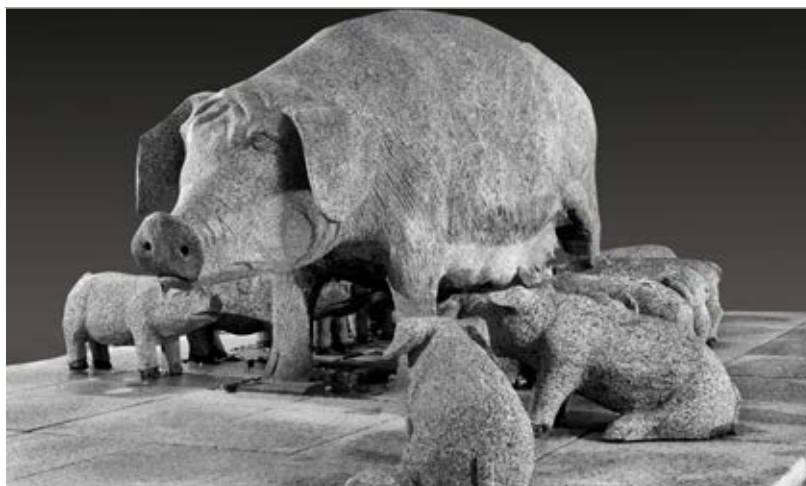

OUR CONTACTS IN OTHER COUNTRIES:

www.acofunki.com/contact-us

Scan the QR code ►
and find the sales person
in your country





CONTENT

5 ACO FUNKI WEBSHOP

7 LIQUID FEEDING

Liquid feeding tank
Residual-free liquid feeding
Components for liquid feeding
FUNKINET PIGGI SOUP
Sensor feeding with FEED MANAGER
Funkinet Milling
Polymer Concrete and stainless steel troughs

20 DRY FEEDING

Phase Feeding concepts
Funkit MultiController
Funkit MultiStraw - Straw distribution system
Outdoor Dry Feeding
OptiScale - Monitoring of pigs growth
MASTER CHAIN & POWERLINE
Flex Auger

36 FEEDERS

FUNKIMAT
TUBE-O-MAT & TUBE-MAT NX
TURBOMAX
Box Feeders
BABY FEEDER
Compact Feeder
AD-LIB Feeder
Combi Feeder
VD100 Floor Feeder
Feed dispensers

50 MATING & GESTATION

Free Access Stall
LD-stall
JUMB-O-FINE Box
Confine Box
Electronic Sow Feeding (ESF)
INN-O-FLEX equipment for sows

58 FARROWING

WELSAFE Farrowing pen for loose sows
FT-30 Farrowing pen for loose sows
Traditional farrowing pens
Sow troughs and feed bowls
Piglet nest
Heating plates for farrowing and weaner pens
FIRST-CARE Rubber Heat mat
"Moving Floor"
BABY CARE Milk Feeding system

76 WEANERS & FINISHERS

FUNKI FIBER
CLEAN-O-FLEX
FUNKI FLEX
Pork Tuner
FLEXCOVER climate cover
PVC board profiles, profiles and plugs

84 FLOORING

COMBI-FLOOR
Self-supporting cast iron slats

90 WATER SUPPLY

Water level valve
Tilt trough
Sprinkling and soaking
DRIK-O-MAT drinking cup
Water valves

94 FEED STORAGE

Galvanized silo
Fibre glass silo

96 BIOSECURITY

CLEAN BOX for disinfection of equipment and tools

97 DANISH PIG ACADEMY

ACO FUNKI PROJECT MANAGEMENT

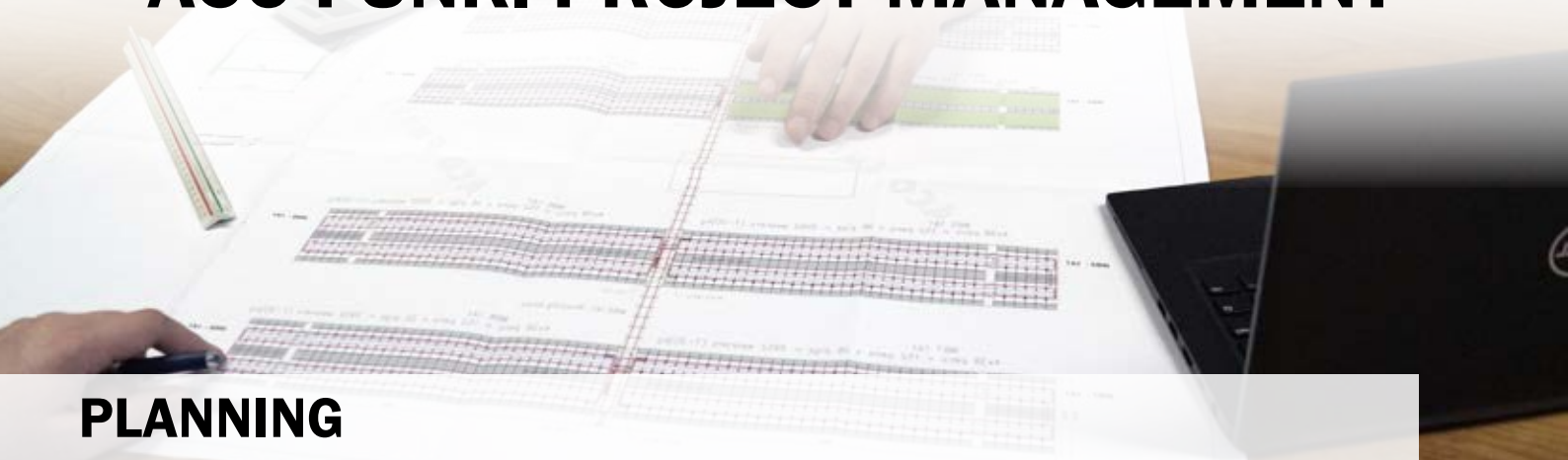

PLANNING



INSTALLATION



HAND-OVER

WE ARE ALWAYS HERE FOR YOU

www.webshop-acofunki.aco.com



At our webshop you can find wide selection of components your pig farm, and we have plenty of products on stock ready to be shipped for you. You are welcome to contact us and we will guide you all the way.

The webshop is intended to make it easier for you to order necessary parts. You can order the products you need - when you have time, without additional fees and at optimal prices.



ADVANTAGES:



Buy when you have time - our webshop is open 24/7



View the current stock status



Fixed low prices on all items



Stock sale products, where you can save up to 70%



No handling fee - save time and money



Fast delivery and good service



CONTACT US:

Tel.: +45 96 26 92 90

E-mail: webshop@acofunki.dk



LIQUID FEEDING

Always fresh feed, good overview, and ability to control feed allocation at the end of the pigs growth period

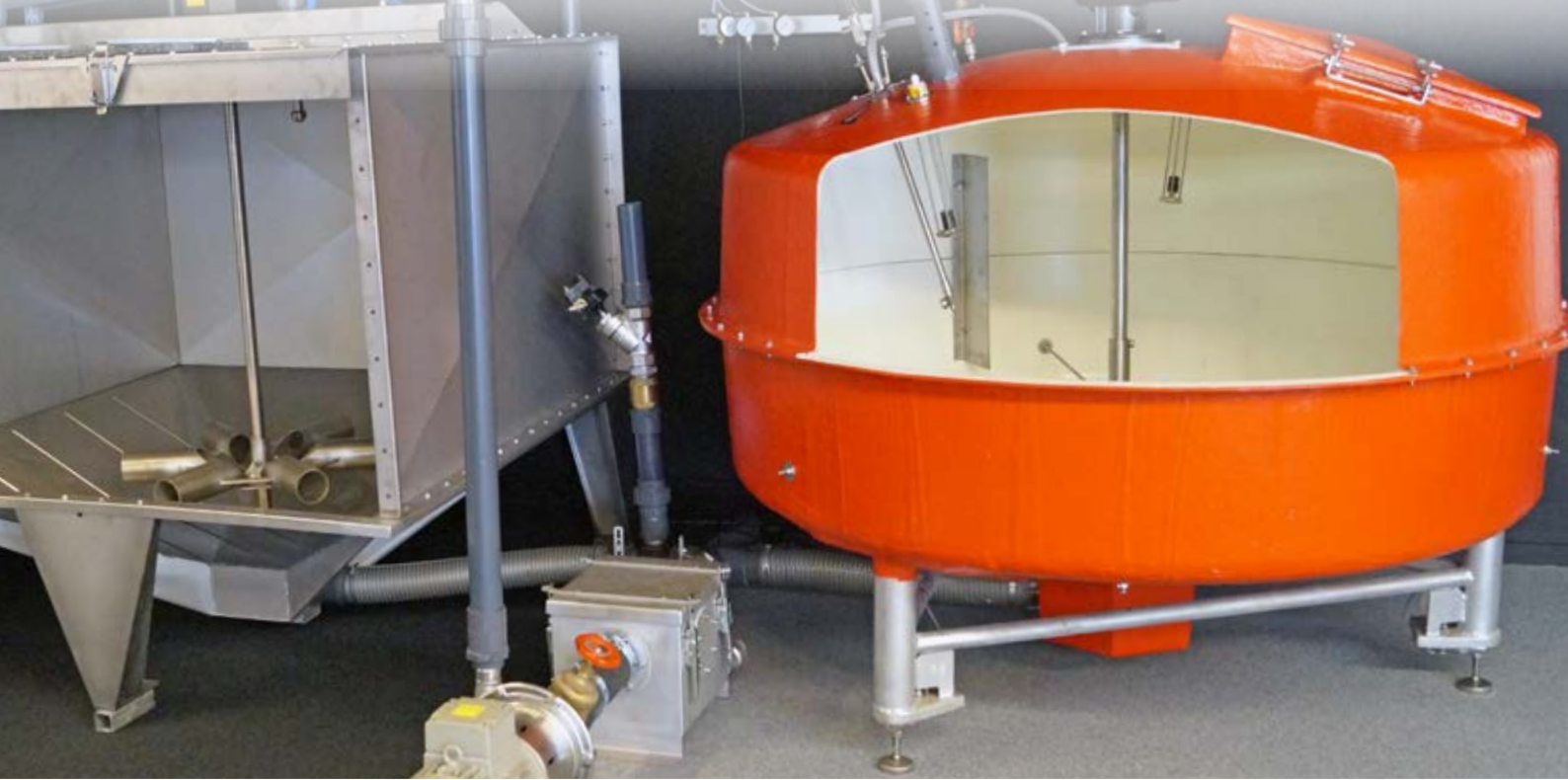

COMPLETE LIQUID FEEDING SYSTEM

Liquid feeding with high level of hygiene // FUNKINET control

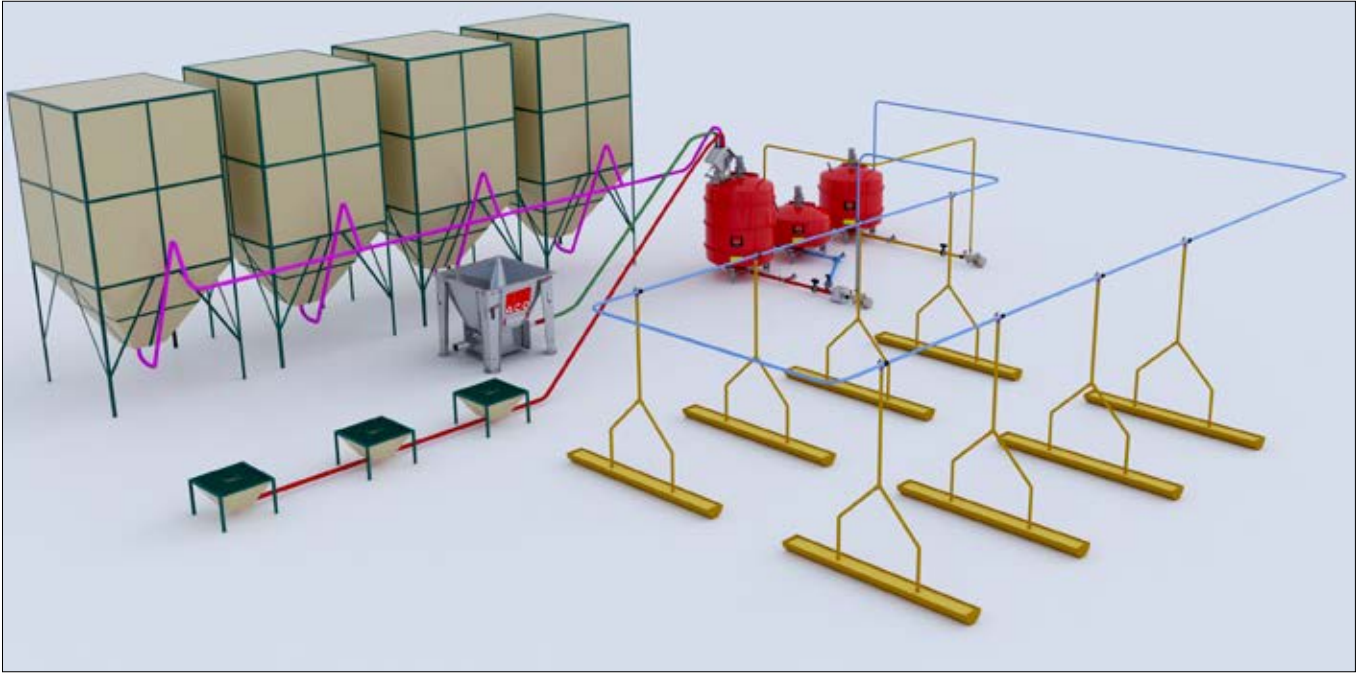

Choose your system

Dry feeding vs. Liquid feeding*

Description	Dry feeding ad-lib	Liquid feeding	Difference per pig	
			Per day	30-110 kg
Daily growth, g	949	959	+ 10 g	1 kg
Feed conversion ratio, kg feed/kg gain	2,75	2,58	0,17 kg	13,6 kg
Meat percentage	60,6	60,9		+0,3%
Saved feed cost per pig				Up to 5,5 EUR/pig

◀ THE CHOICE IS YOURS

Feeding strategy and feeding method

Source: Note no. 1073, Danish Pig Research Center.

*Home mixed flour feed



BENEFITS AND RESULTS OF LIQUID FEEDING

- Higher feed intake and growth
- Lactic acid bacteria improve the gastrointestinal health
- Lower feed expenses
- Automatic feed allocation control
- Reduced risk of salmonella, and lower incidence of coli bacteria
- Improved feed conversion ratio - savings equivalent to 20 kg of feed per finisher
- Feed consumption up to 10% lower
- An increase in daily growth of up to 6%
- Achieve slaughter weight in less time

LIQUID FEEDING

10% lower feed consumption with FUNKI LIQMIX mixing tank

ACO FUNKI offers residual-free liquid feeding system of a high quality. Advanced technology ensures an efficient investment. The main benefits of liquid feeding are fresh feed and good overview. Similarly, it is possible to use by-products from the food industry, as well as to manage feed allocation at the end of the pigs growth period. The liquid feeding is especially cost effective for finishers, because feed costs increase significantly. The liquid feed is easy for pigs to consumpt - especially for piglets. Good feed intake is a prerequisite for growth accelerating, so that the pigs reach slaughter weight in less time.

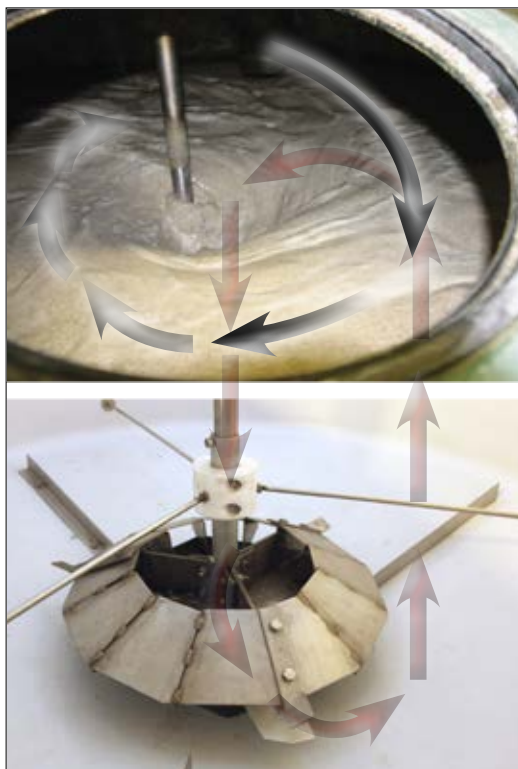

▲ FUNKI LIQMIX

The mixing tanks for liquid feeding are available with capacity from 2 to 10 tons.

HIGH LEVEL OF HYGIENE IN THE LIQUID FEEDING TANK

1. Acid evaporator

Effective bacterial control with acid. Ensures high hygiene in the liquid feeding tank.

2. UV light

Prevents bacterial and fungal growth. Works optimally with well-functioning high-pressure systems.

3. High pressure cleaner

Rotary nozzle head that cleans the inside of the tank with high pressure water.

4. "Clean Feed Intake"

Self-cleaning component inlet for the wet feeding tank; with close shutter.

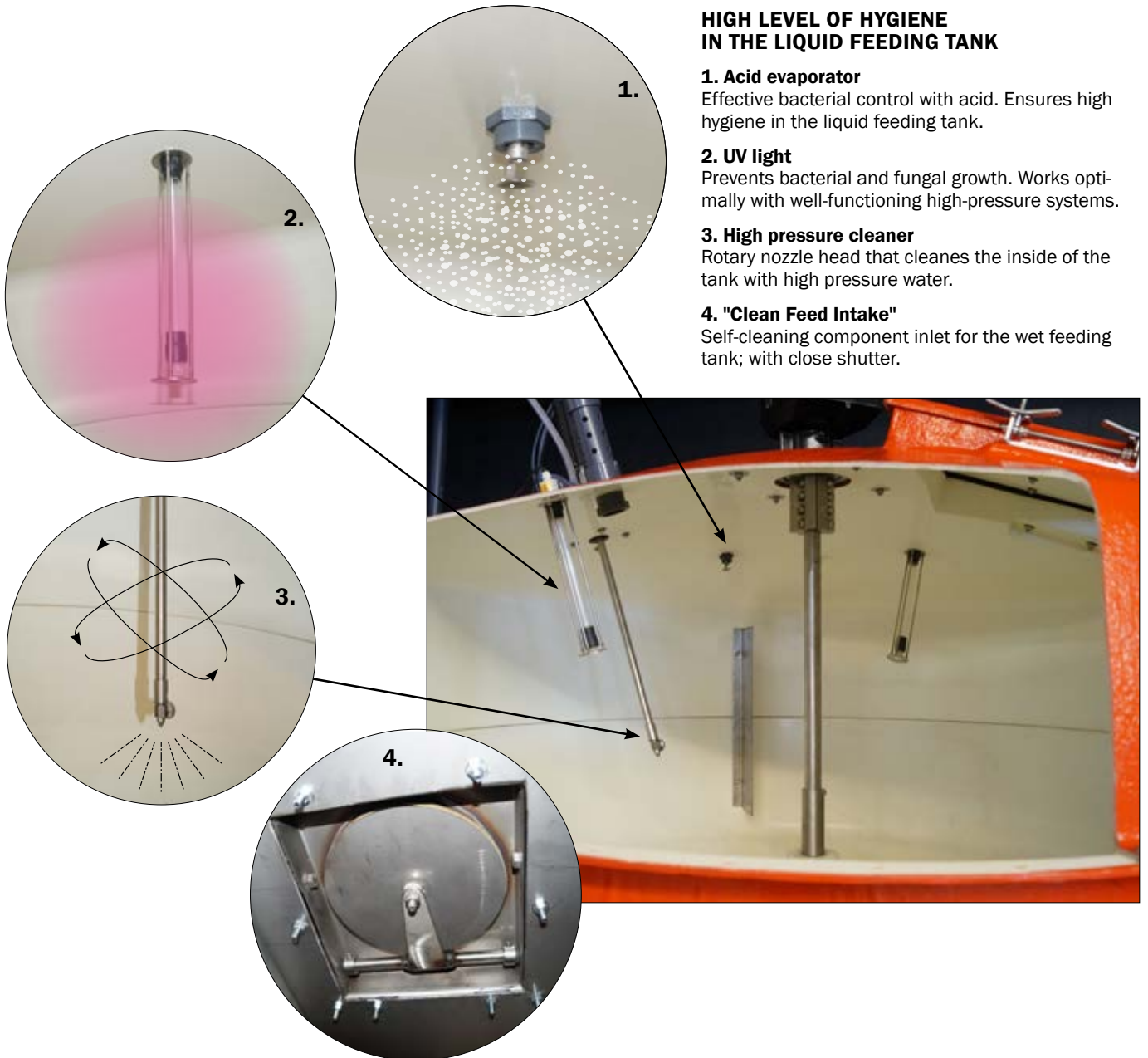

◀ COMPONENT INLET

The component inlet damper ensures that no moisture is penetrating the feed downpipe from the mixing tank. In addition, the component inlet is designed so the feed flow cannot be blocked.

LIQUID FEEDING

Residual-free

RESIDUAL-FREE LIQUID FEEDING

Residual-free liquid feeding is a feeding method that ensures no leftovers in the feed pipes after feeding. This ensures fresh feed for each feeding, and not a mixture of new and old feed.

- Increased number of weaned piglets with approx. 3 per sow per year
- Increase in piglet weight by weaning up to 1.2 kg
- Medicine consumption reduced by 50%
- No loss of amino acids
- Return on investment: 1-1.5 years

BEFORE FEEDING ►

The mixing tank has the mixture ready. The tank for residual water is empty. The tank for clean water is full and there is clean water in the pipe line.

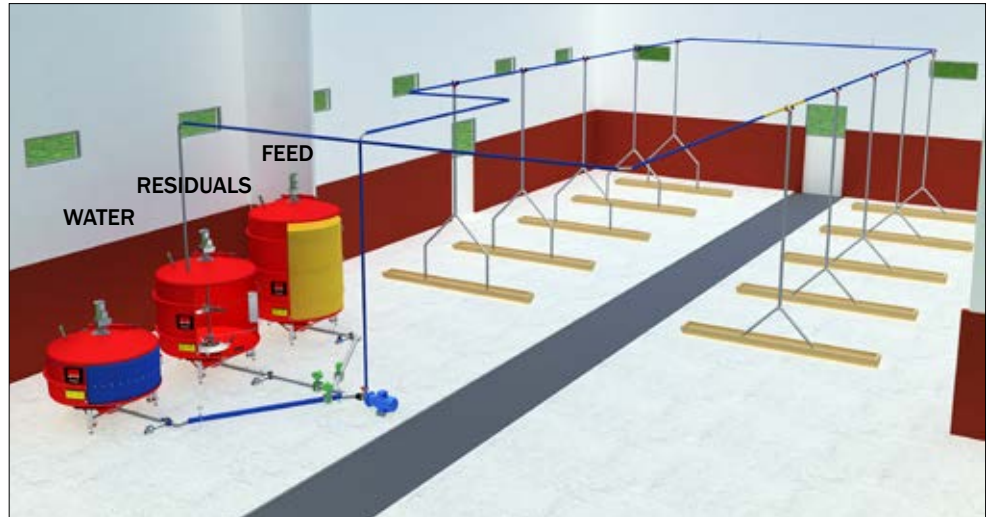

DURING FEEDING ►

The mixing tank is emptied. The tank for residual water is filled. When there is no longer feed in the mixing tank, the water is pumped from the clean water tank. In this way, the clean water tank is used to distribute the feed left in the feed pipes, and when the last valve has been fed, the feed pipes are filled with water.

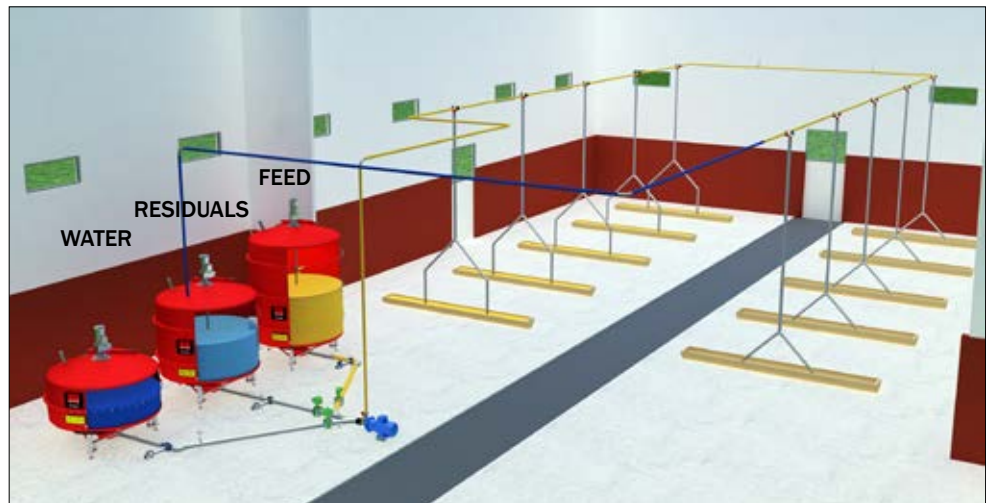

AFTER FEEDING ►

The mixing tank is empty. The residual water tank is filled up.

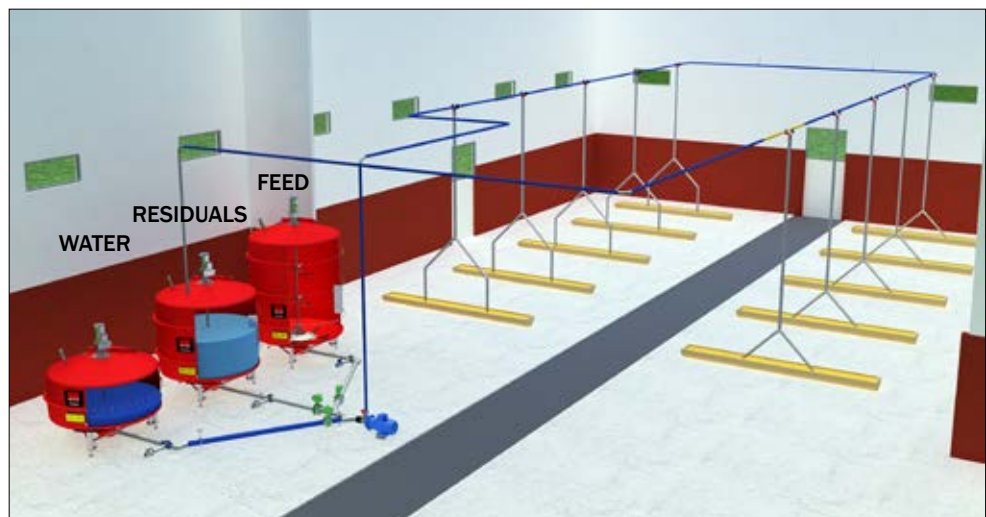

CENTRAL PIPING WITH SECTION PIPES WITHOUT RETURN

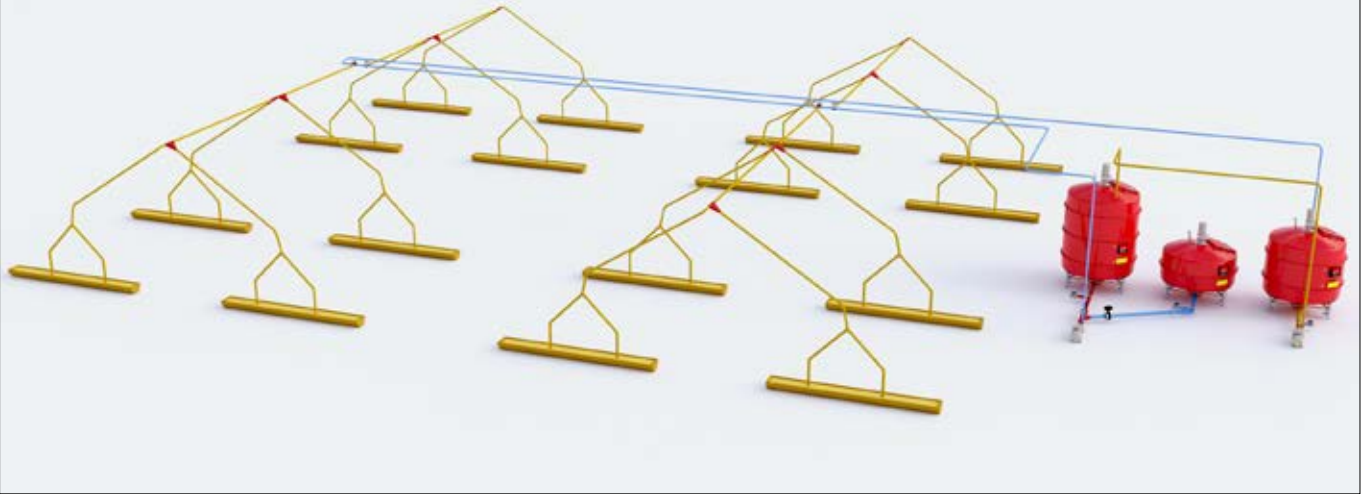

CENTRAL PIPING WITH SECTION PIPES WITH RETURN

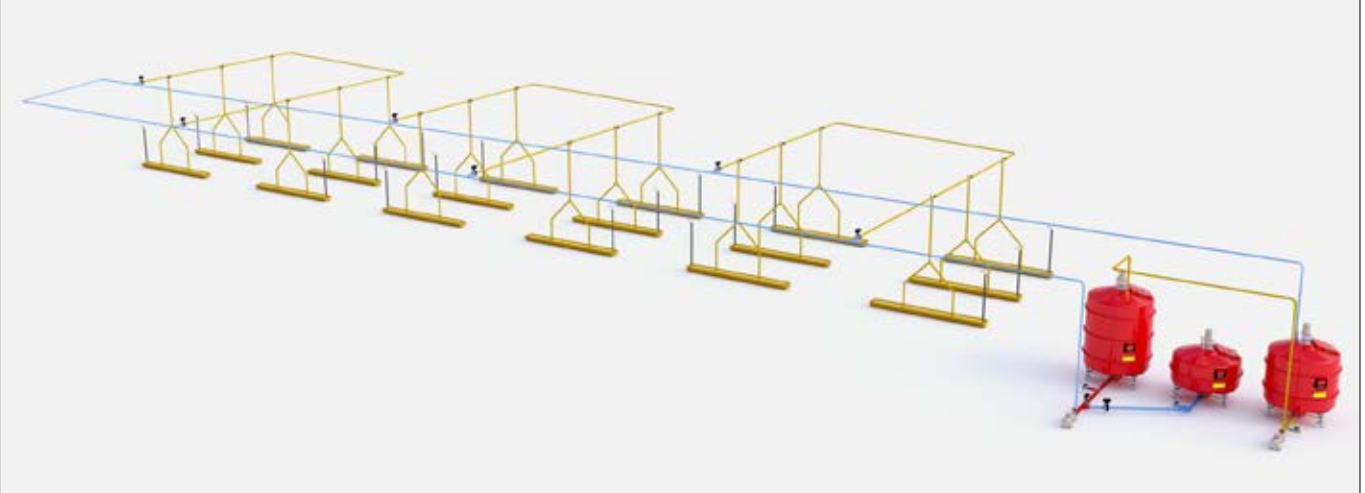

AD-LIBITUM FEEDING FOR BOTH SOWS AND WEANERS

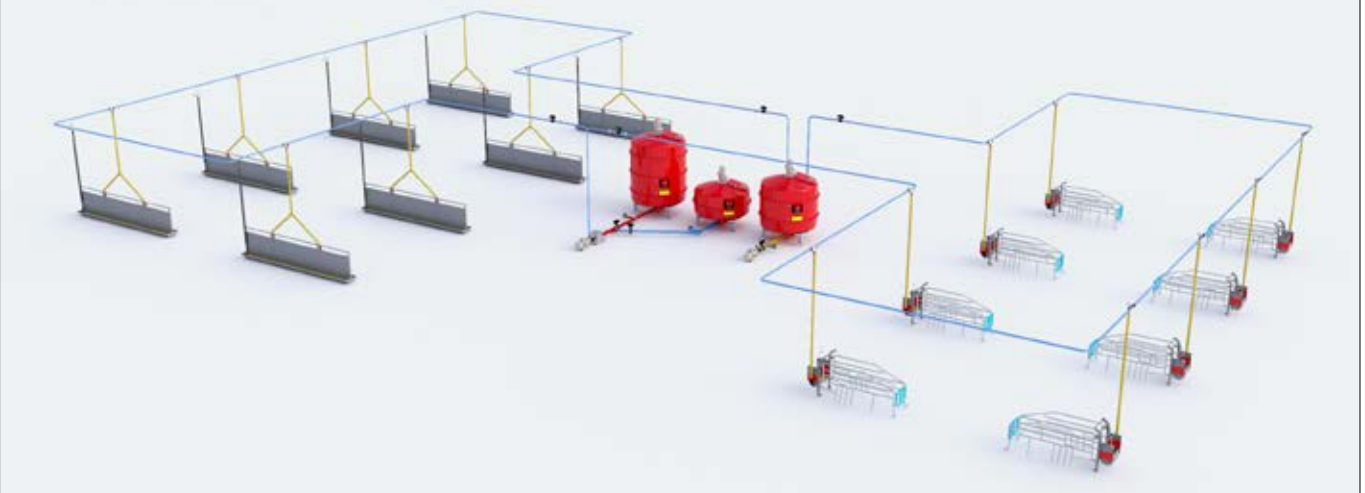



COMPONENTS FOR LIQUID FEEDING

High performance equipment from silo to trough

If the farm staff spend more time on direct animal care, animal welfare and comfort will be reflected in financial performance at farm operation. Full automation of feed mix and feed distribution with ACO FUNKI's liquid feeding system releases more time for staff to pay attention to the animals.

◀ COMPONENT INLET AND CCM

CCM corn is a good feed ingredient for liquid feeding. From the CCM tank the corn "snails" directly into the liquid feeding tank. The mixing tank is available in different sizes, depending on the farm capacity. The design of the tank is critical for the feed quality. One of the most important criteria for feed quality is a uniform consistency and sufficient fluidity. These properties are obtained by appropriate mixing of the components in the feed mix.

Our mixing tanks are made of robust fiber glass. The tanks have completely smooth inner walls as well as a streamlined shape that prevents unwanted deposition of feed and ensures quick and easy cleaning.



Testimonials:

“ We have 8.000 sows and produce 240.000 finishers annually. All our sows and finishers are fed by means of residual liquid feeding system from ACO FUNKI. We use CCM corn for all the animals. We now have 3 CCM plants with a volume of 20 - 60 m³ each. The system runs smoothly daily.

Mogens Hansen, DanSlovakia

COMPONENTS FOR LIQUID FEEDING

Microdosing system and feed valve



◀ MICRODOSING SYSTEM

The system dosates small amounts of vitamins, minerals and other additives with gram accuracy. The system is equipped with special stirring and has a capacity of 10 liters. The entire system is made of stainless steel.



FEED VALVE ▶

- Optimal hygiene and no feed residuals
- Easy to mount
- Strong rubber membrane with long durability
- Stainless valve cover ensures that the valve stays tight
- Flexible - can be rotated in all directions



Ø40mm = 0,91 kg feed/m
 Ø50 mm = 1,42 kg feed/m
 Ø63 mm = 2,55 kg feed/m

STONE TRAP ▼

When the feed flows from the mixing tank, it passes the stone trap. Here, small stones and other foreign objects are being sorted out. This provides additional protection for the pump. At the same time, the pigs get cleaner feed mix.



PUMPS ▶

ACO FUNKI's liquid feeding system uses electrical pumps for feed transport. This type of equipment is subject to great wearing-down due to the fact that it works almost without interruption. Unlike other pumps on the market, our pump has an advantage because it is made of stainless steel with a thickness significantly greater than other manufacturers'. This ensures a longer lifetime of the pump and a durable operation of the entire system.

- Centrifugal pump 4 kW or 5.5 kW
- Distribution speed 1-7 l / sec



TYPE OVERVIEW - PUMPS

Article	Description	Max Output Tons/hour	Feed output		Max pressure, Bar	
			Liter / min	Tons/hour	50Hz	60Hz
0138-689	Centrifugal pump for water 1,1 kW , motor 380V, intake 2', outlet 1¼'	12	200	12	-	-
0139-138	Liquid centrifugal pump 5,5 kW , 220/380V, intake 3', outlet 1½'	25	360	21	4,8	7,2
0300-125	Worm pump arr. nemo 4 kW 2-step 2kW, intake PVC Ø90 mm, outlet PVC Ø63 mm	15	150/270	9/16	-	-



FUNKINET PIGGI SOUP

Liquid feeding for weaners

Piggi Soup is a residual-free liquid feeding system for weaners. It is a great start right after weaning: the system makes small dosages of liquid feed with short intervals and distributes it to pigs, which means they always get fresh feed. Furthermore, liquid feed is easy to digest, and the weaners start gaining weight from the first day.

- Alternative to the time-consuming manual feeding
- Requires less manual labor
- The continuity of the process increases the output of the production
- Automatically scheduled cleaning keeps bacteria level at a minimum
- Less mortality rate of the small piglets



TIRED OF THE MANUAL LIQUID FEEDING?

Manual feeding of the small piglets has shown significant improvement in growth, when dosing with adequate products. However, the manual feeding requires a lot of man-hours, and in general dosing won't happen when pigs are hungry, but when people are at sight. *Therefore, we have developed the Piggi Soup system.*

HOW IT WORKS

Piggi Soup keeps water and acid as stabilizer in pipes and distribution tank during the night when the system is inactive. During the first feeding of the day, water intake is done through pipe circuits, ensuring any small residuals are rinsed out, towards distribution tank.

Piggi Soup will afterwards finalize the intake, fill pipe circuits calculated for distribution, and dose portions in the speed, piglets are able to consume their rations. Between each dosing the system is in pause mode, waiting to distribute.

RESIDUAL-FREE LIQUID FEEDING FOR WEANERS

Smart solution for healthy pigs

- Zinc-free weaning
- Always fresh feed thanks to frequent mixing and dosing in small quantities
- No feed residues in the pipes during break periods
- Pigs get all the food they need and therefore grow faster from day one
- Minimum feed amounts in the system



ZINC-FREE WEANING

It is important that the pigs learn to eat before weaning. Then the intestine has become accustomed to digesting plant-based feed, and the pigs have learned to get to the trough.

Therefore, SEGES Pig Production recommends various measures for weaning without medicinal zinc. One of them is the allocation of liquid feed 3-4 times a day - both before and after weaning. This is exactly what the Piggí Soup system is made for.

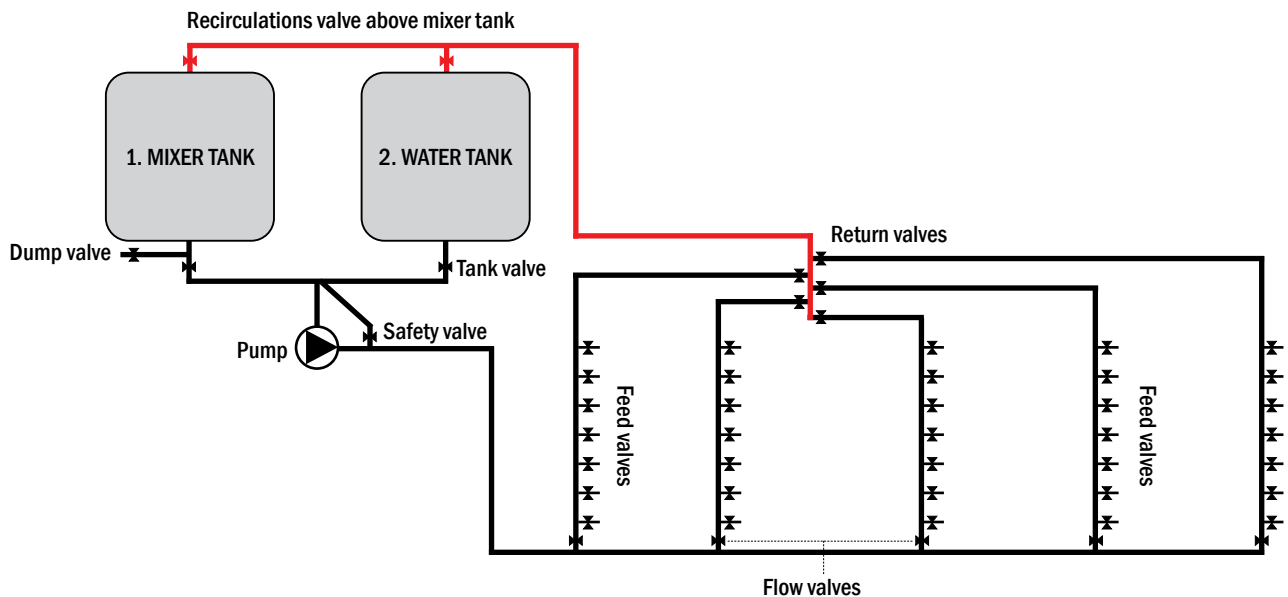

Testimonials:

“ It is an advantage that the piglets start with liquid feeding. It ensures zinc-free weaning.

In addition, we already have an ACO FUNKI multiphase system in the rest of the barn, which works well together with Piggí Soup.”

Ralf Bager, Kærgården Agro, Denmark
1600 sows, 55.000 weaners

LIQUID FEEDING

Sensor feeding with FEED MANAGER

FEED MANAGER - ensures the animals get the correct amount of feed.

With ACO FUNKI's FEED MANAGER, you have an intelligent system that automatically adjust the amount of feed, depending on time pigs spend on eating. The special sensor is placed in the trough to register how fast the pigs eat. The principle is simple: there are settings for the optimum eating time. If the pigs eat slower, they get less feed next time. If the pigs eat faster, they get more feed next time, though up to a maximum amount. Fully automatically system that ensures more rational use of feed.

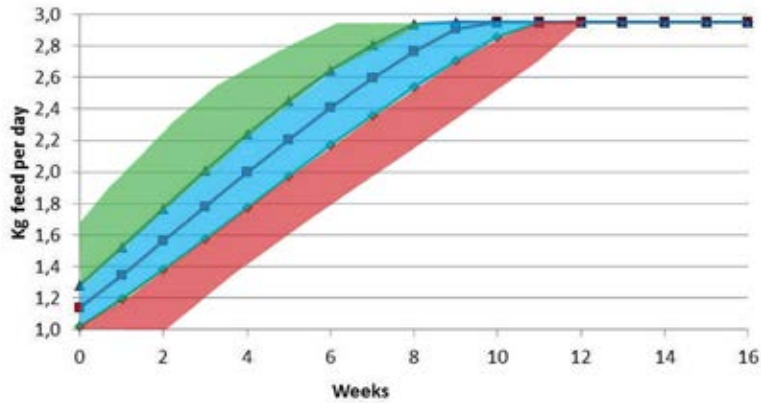
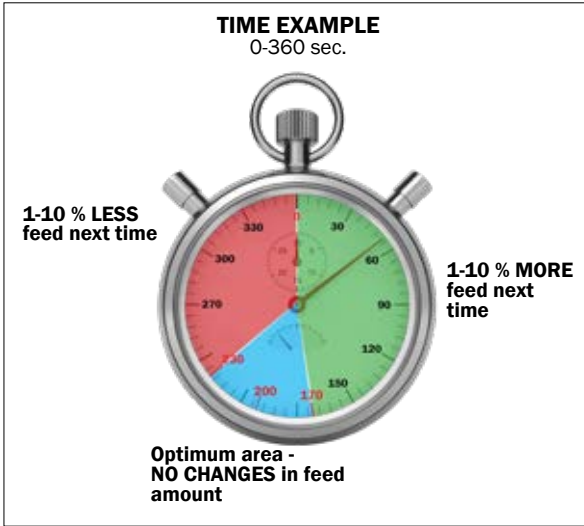

▲ SENSOR

The FEED MANAGER's sensor detects how long it takes before the feed is eaten up.



Testimonials:

“ It is very reassuring to know that the system can detect how quickly the pigs eat, and then adjust the amount of feed according to the feed curve. We have experimented with the parameters in the feed curve and have now found an optimal solution. The system is very flexible and has many options for optimization. Based on our experience, we have now decided that Feed Manager will be used in all our stable sections in the future.

Jørgen Krøjgaard, Herning, Denmark

Production results:

- 2,62 FU/kg growth
- 1007 gram daily growth
- 1,3% mortality
- Meat percent: 60,5



FUNKINET MILLING

Different options

With FunkiNet milling, you get the optimum overview; at the same time, consumption and mixes are shown in the same screenshot as your feed plant. And with up to 50 feed recipes and silos, you are secured far into the future, regardless of the capacity of the mill. With your own mill, you will have the opportunity to quickly adjust the feed mixes and get better welfare for your animals.

ACO FUNKI offers milling solutions of all sizes and functionality, according to your wishes and requirements.

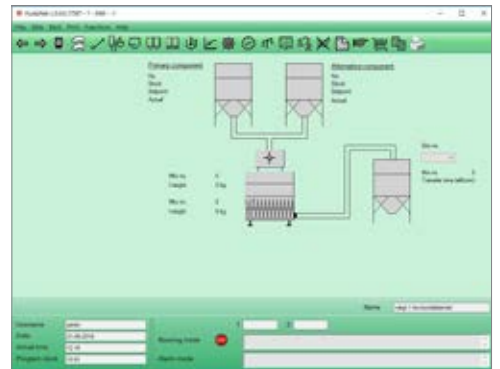



TROUGHS

Made of polymer concrete or stainless steel

Polymer concrete troughs

The troughs made of polymere concrete have a smooth surface that is very practical and hygienic. The troughs are resistant to influence of chemicals, feed and waste products.



TYPE OVERVIEW - TROUGHS MADE OF POLYMER CONCRETE

Article no.	Description	For	Dimensions (HxWxL) (mm)	Volume (l/m)
02564	Trough TS 25	Weaners and finishers	143 x 300 x 1000	22
01605	Trough TS 30	Weaners and finishers	155 x 330 x 1000	32
01667	Trough TS 35	Sows	168/218 x 390 x 1000	38
02571	Trough TS 36	Sows	180/300 x 410 x 1000	42
03191	Double trough TS 41	Finishers	180 x 460 x 1000	50
01585	Double trough TS 47	Finishers	180 x 530 x 1000	55
02101	Double trough TS 50	Finishers	180 x 580 x 1000	65
18444	Trough TS 28 V	Sows	150/220 x 300 x 1000	30

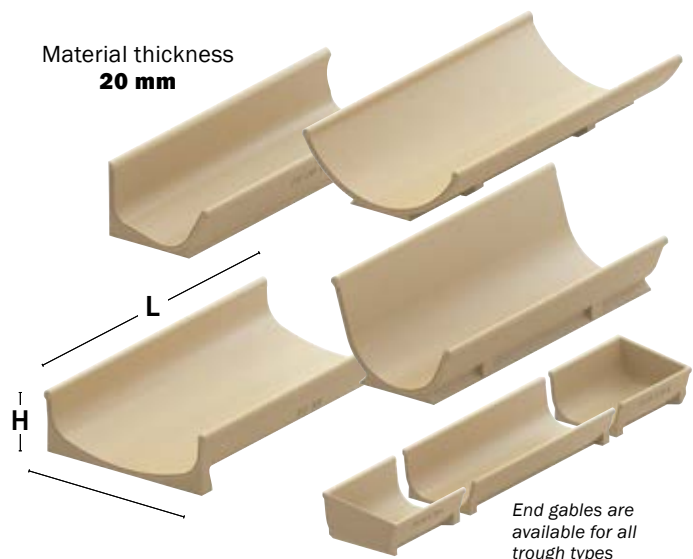

TROUGHS

Stainless steel troughs

- Everlasting: made of stainless steel
- Minimal feed waste: inverted edges
- Hygiene and animal welfare: The edges are rolled on the outside so the surface is smooth on the inside. Minimising the risk of accumulation of feed remains and injuries to the animals
- Flexibility: Individually adapted length from 60 to 600 cm
- Cheap assembly: Easy handling, as the troughs are lighter than concrete
- Easy to clean: The troughs are elevated from the floor, allowing washing underneath them



◀ Loose gables



◀ Welded gables

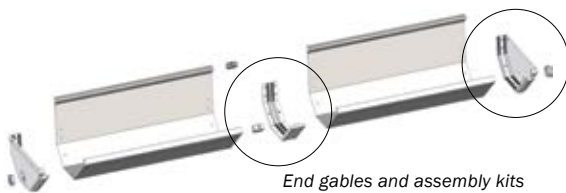

End gables and assembly kits

STAINLESS STEEL TROUGHS for all box types and INN-O-FLEX (Length 0,6 - 6 m)

Description	Volume (l/m)	Height	Upper width	Lower width
For boxes with front bars	32,5	14,3 cm	32,5 cm	11,5 cm
For boxes with front gate	32,5	14,3 cm	32,5 cm	11,5 cm

STAINLESS STEEL TROUGHS for INN-O-WALL (Length 1 - 6 m)

Description	Volume (l/m)	Height	Upper width	Lower width
Double trough for Wean-to-Finish, finishers and gilts	49	14,5 cm	49,7 cm	20 cm
Single trough for Wean-to-Finish, finishers and gilts	24,5	14,5 cm	24 cm	7 cm
Double trough for weaners	38	12 cm	43 cm	20 cm
Single trough for weaners	16	12 cm	20 cm	6 cm

▼ STAINLESS STEEL TROUGHS WITH DRAIN



All troughs are available with the length 6100 mm and with 2" plug (ext. thread).

The drain plug makes it easier to empty the trough.

Besides, there are no sharp edges and the risk for injuries is minimal.



Foot bracket and support leg for double trough, weaners and finishers



Foot bracket for single trough, weaners and finishers

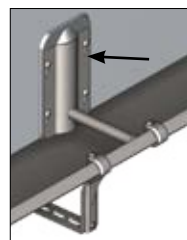

Adapter for support leg 35 mm PVC plate

BIOLINE TROUGHS



- With head/shoulder partition
- For partition and wall mounting
- From 4 to 7 pigs per eating place
- Ad libitum feeding
- Strong stainless trough
- Gentle to pigs
- Long durability

FACTS

Options	With 5, 7 or 9 eating places
Material	Fiber plate, 10 mm
Size per eating place	220 mm

BIOLINE TROUGHS

Article no.	Eating places	Dimensions (H x D x W, mm)
39902	5x2	750 x 1100 x 430
39912	7x2	750 x 1600 x 430
39922	9x2	750 x 2000 x 430

DRY FEEDING

Accurate feeding, traceability, lower feed costs, reduced environmental impact and latest technologies characterize ACO Funki's dry feed solutions



FEEDING SYSTEMS



FEED DISPENSERS



FEEDERS



MULTI PHASE FEEDING

FunkiNet Dry Single concept

Phased feeding is a strategy where multiple feed mixes are distributed to a group of pigs based on feed curves or weight ranges to precisely meet the pigs' nutritional needs.

FunkiNet Dry Single concept can run with two independent dry feeding systems at the same time. That gives the system a unique high capacity.

Each feeder has an empty sensor and it is possible to decide the amount of feed and how often it has to fill the feeders. Thus, you can control the feed amount and the feed mix of each pen.

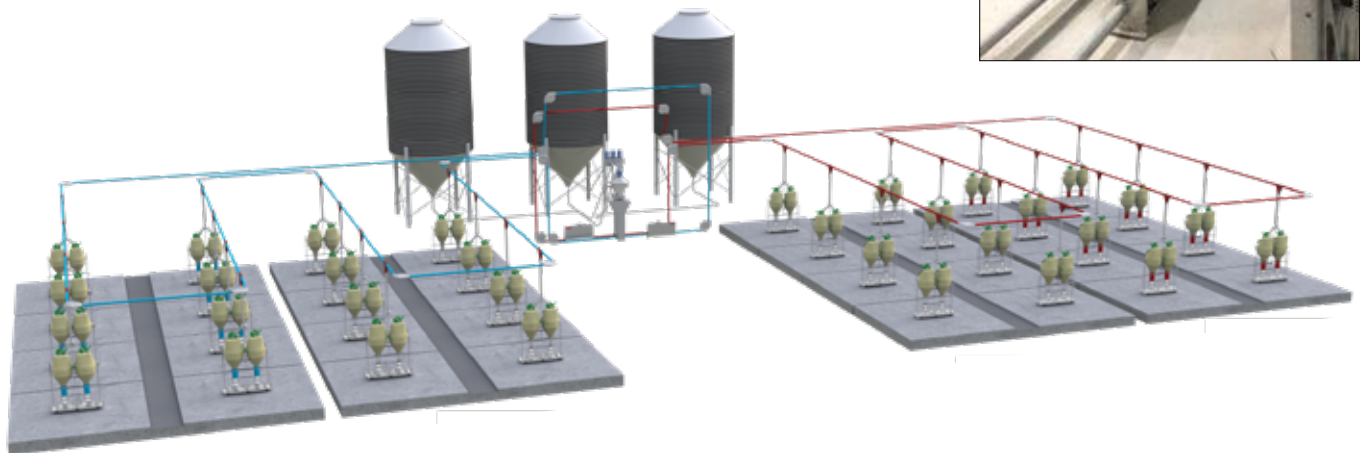

▲ The **FUNKINET DRY SINGLE** concept can operate with two independent dry feed systems at the same time. This gives the system a uniquely high capacity.

- Exact feed mixing
- Feed consumption registration for every pen
- Full traceability
- High growth
- Low feed waste
- Low emissions of Nitrogen and Phosphorus
- Reliable
- Can be configured to feed sections instead of single pens



Testimonials:

“ We can have a smooth transition between feed mixes so that the pigs cannot feel this transition. ”

We basically don't see stomach problems and we have much lower medication consumption."

*Ralf Bager, Kærgården Agro, Denmark
1600 sows, 55.000 weaners*



PHASE FEEDING CONCEPTS

Dry feeding systems for sows, weaners and finishers

We offer phase feeding system for sows (FUNKI SOW MULTI) as well as for weaners and finishers (FUNKI DRY MULTI). The systems work according to the similar principle and deliver the right amount of feed to the animals at exactly the right time.



◀ PHASE FEEDING OF SOWS

The system helps to ensure better welfare, helps to reduce piglets mortality and at the same time helps to reduce risk of fever.



◀ PHASE FEEDING OF WEANERS AND FINISHERS

The system ensures higher growth and lower feed waste, as the feed is used optimally. The perfect solution if you want more healthy pigs and a better working environment.

MUTIPLE SOLUTIONS:

- 1 COLOR FEED SINGLE
- 2 COLOR FEED GROUP
- 3 AUTO FEED CURVE
- 4 AUTO FEED SECTION



◀ MULTICONTROLLER

By using the MultiController as a phase feeding controller, it is possible to run up to 6 different feeds in one feed valve or circuit system in the Color Feed concept.



◀ ONE BUTTON CONTROLS THE ENTIRE ROW:

- Mix 1 █ Mix 4 █
- Mix 2 █
- Mix 3 █ Mix 6 █

1 COLOR FEED SINGLE

Phase feeding on a pen level

COLOR FEED SINGLE

- Regulates the feed type individually for each pen.
- At each Master Valve, there is a contact for manual control of which feed type should be used
- If the red valve is open, the feed dispenser will be filled with feed mix 1 - **RED**

FEED MIX OPTIONS WITH COLOR FEED

FEED	MIX OF 2
6	0
5	1
4	2
3	3
2	4



COLOR FEED SINGLE: Phase feeding valve in a weaner unit



COLOR FEED SINGLE: Phase feeding valve in a farrowing unit

2 COLOR FEED GROUP

Phase feeding on a section level

COLOR FEED GROUP

- Regulates the feed type for each section.
- There is an air switch on each row, typically just outside the section or row to manually determine what feed will be used in the section.
- If the valve "Yellow" is open, the dispensers will only fill with Mix 2 - **YELLOW**.

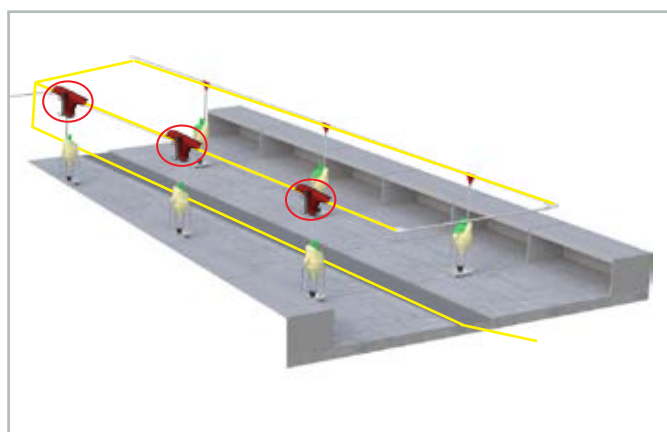

COLOR FEED GROUP: Phase feeding valve in a weaner unit

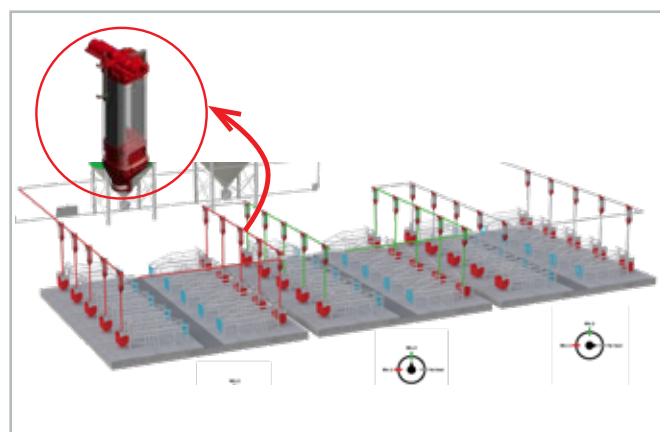

COLOR FEED GROUP: Phase feeding valve in a farrowing unit

Amount of feed, kg

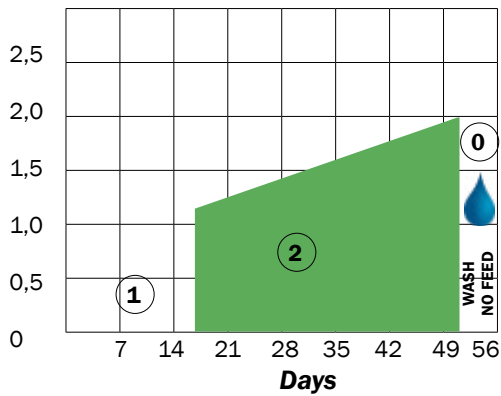

AUTO FEED CURVE

- Run automatically up to 4 different feed types in one circuit system. For example, 4 feed types and 3 mixes.
- For each Row or Section, 2 solenoids (one for opening and one for blowing out) can be mounted centrally, or just outside each place. Funki Dry/Sow Multi can run up to 32 groups per feeding system.
- In the MultiController software, each group is defined with a feed curve. This curve will daily determine if the pen will receive the feed type 1 - 7.

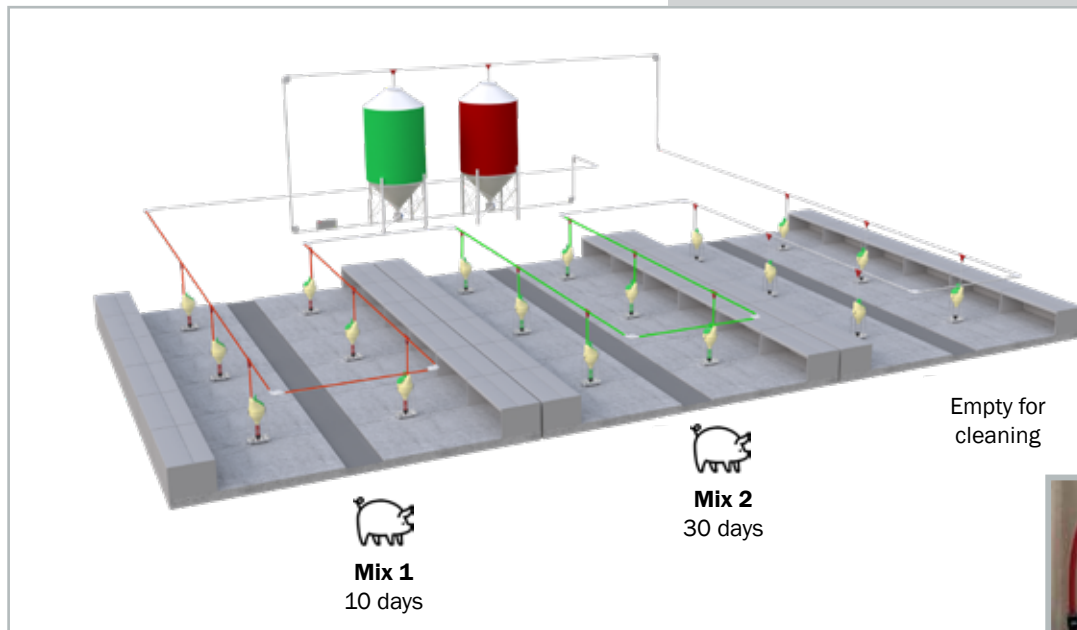

AUTO FEED CURVE: Phase feeding in a weaner unit

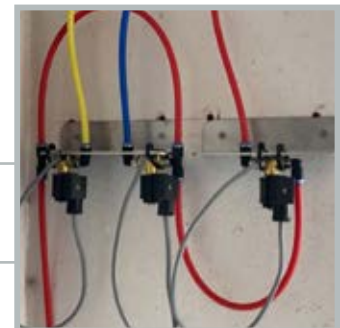

Automatic open and close magnetic valve per section per feed mix

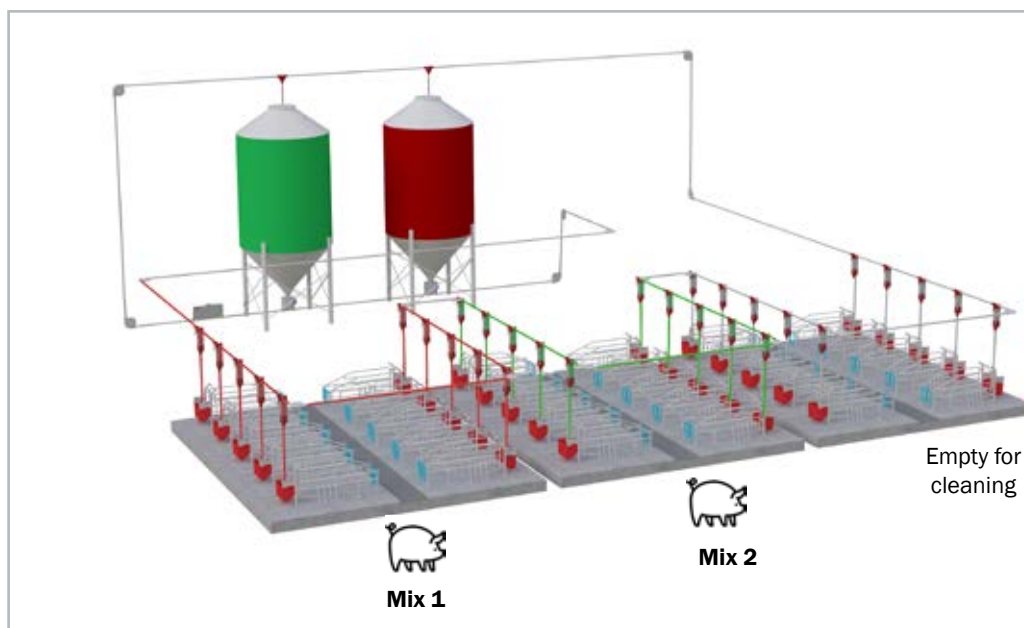

AUTO FEED CURVE: Phase feeding in a farrowing unit

AUTO FEED SECTION

- Funki Dry/Sow Multi Section is a flexible dry feeding control unit which is very easy to operate.
- The system can be adapted according to individual customer's needs and wishes.
- Funki Dry/Sow Multi Section can be made for both phase feeding and step-phase feeding.
- The multi-phase feeding will mix the feed from 2 silos with frequency regulated speed control and there is a return silo for each section.

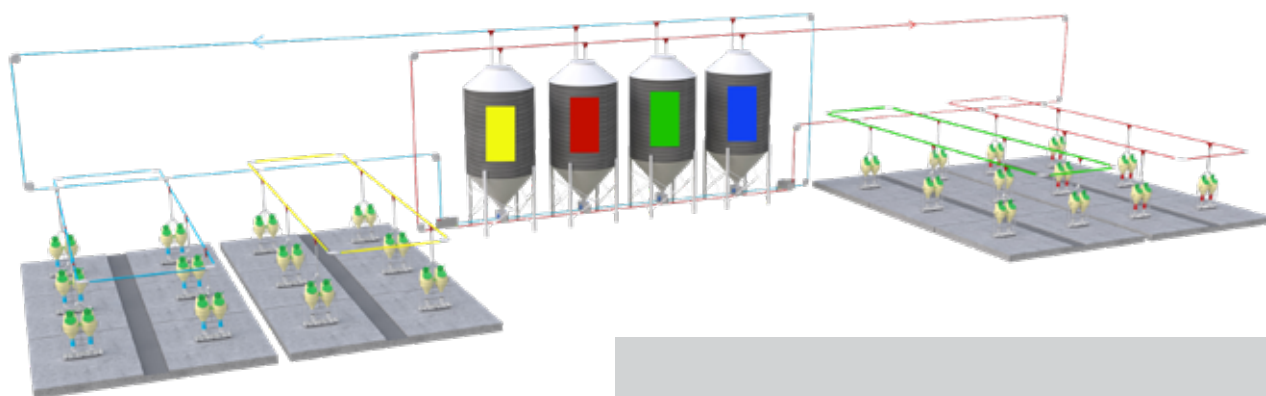
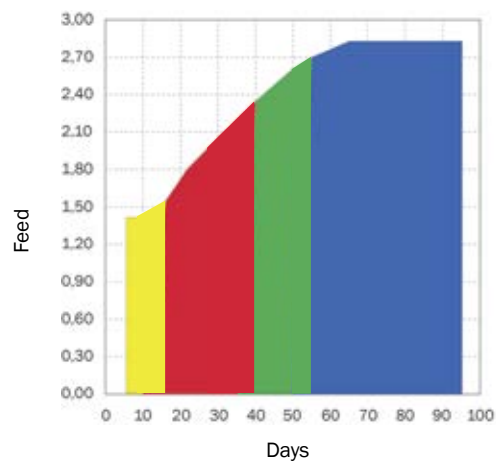
**AUTO FEED SECTION: Phase feeding in a weaner unit**

- One pipe to pipe connection outside each section.
- One feed line for each pig section.
- Feed type Curve and Room = Section.
- This solution will work with standard feed dispensers

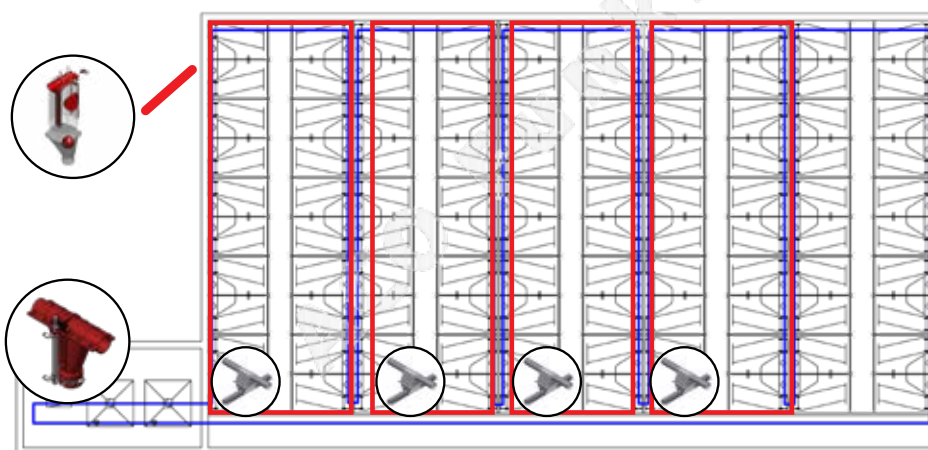
**AUTO FEED SECTION: Phase feeding in a farrowing unit**

MULTIFARM NET

FARM MANAGEMENT | FUNKI MULTI CONTROLLER



FUNKI MULTICONTROLLER

controls all the important systems in your barn.
You can check data either via APP
on your mobile or via your computer.



FEED TRANSPORT

- Control up to 4 silos and 5 pipe strings
- Many options for different dry feeding systems



FEEDING CONCEPT

- Dry feeding
- Phase dry feeding
- Fully automatical



SILO SCALE

- Measure feed consumption
- Scale under the silo
- Weight on feed string for each section

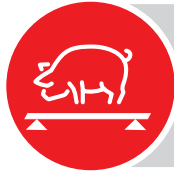

PIG SCALE

- Accurate monitoring of weight
- 24/7 overview
- Registers the pigs growth curve day by day



WINCH SYSTEM

- Controls the scraping system



CLIMATE

- Ventilation
- Heating
- Cooling
- Microclimate



LIGHT

- Light program adapted to the needs and welfare of the pigs
- Energy savings
- Optimal workflow



STRAW SYSTEM

- Automatic distribution of straw
- Up to 400 m per system
- Optimal straw consumption and less straw waste



WATER

- Daily water consumption
- Good overview of the pig's performance
- Early warning of problems
- Higher yield

FUNKI MULTI CONTROLLER Smart Farm Management system

FUNKI MULTI CONTROLLER is a complete automation system for pig farms. The system regulates, controls and monitors such important systems in your pig barn as climate, feeding, water supply, lighting, animal weighing and so on.

This smart, user-friendly automation system gives you total control over all your barn processes and increases the profitability of your business operations. It also makes your work a whole lot easier!

The automated feed and water control system ensures that your animals receive the right amount of feed and water on time and that you have insight 24/7 into feed consumption and feed costs.



MOBILE APP

◀ FUNKI APP

FUNKI App allows you to manage your stable's computers with your smartphone or tablet.

After installing software on your device, you can connect to FUNKI computers in the stable via Internet and SmartLink-RM. Then you have control over them.

The screens and buttons in the App are the same as in the FUNKI computer. This results in recognizable user interface and ensures fast and precise management of the stable computer - wherever you are.

COMPUTER INTERFACE ►

With the Funki Farm Management program you can quickly and easily view and compare results of animal weight, climate, feed and water intake and more, for all the barns.

This program provides clear visualisations of all relevant barn data in the form of charts and diagrams on your PC. You see an overall picture of the living conditions of your pigs, at a glance.

The dashboard of this management program can also be set up based on your personal wishes. You decide for yourself which data is most important to see and compare.

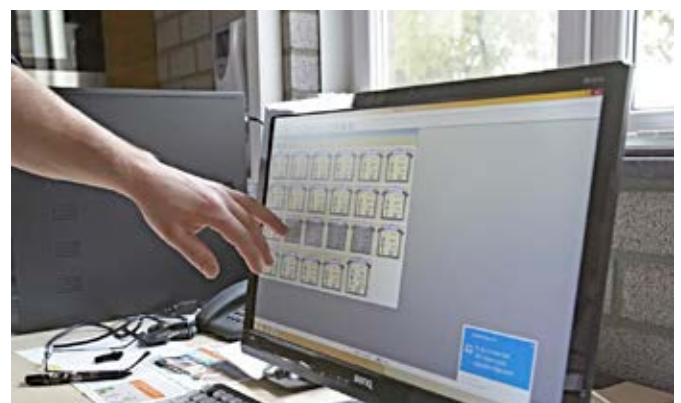

COMPUTER



FUNKI MULTI STRAW

Automatic distribution of straw for pigs and cattle

Funki MultiStraw transports cut straw by means of the special transport system, controlled by Funki MultiController.

Along with the straw dosing units, this provides a system that can distribute straw at the desired times and amounts during the day.

- Straw humidity of max 14%
- Straw length max up to 4 cm
- Dosing system capacity: 3-8 m³
- No bridging
- Option for chopping and tearing equipment
- Special Powerline chain for transportation of straw



Works with straw and sawdust

You can design the system according to individual needs and farm layout. Each line in the system has a max length of 400 meters, and it is possible to design the system in several lines according to the farm layout.

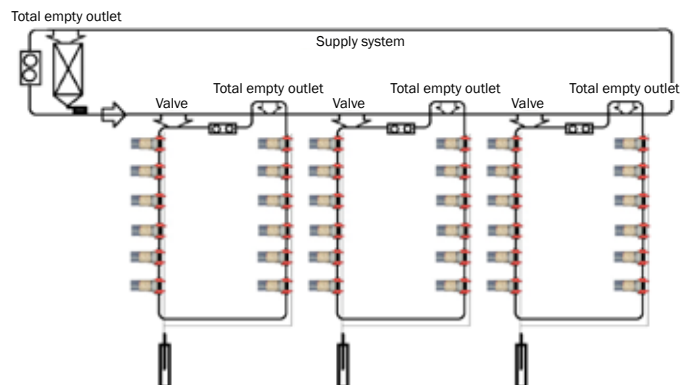
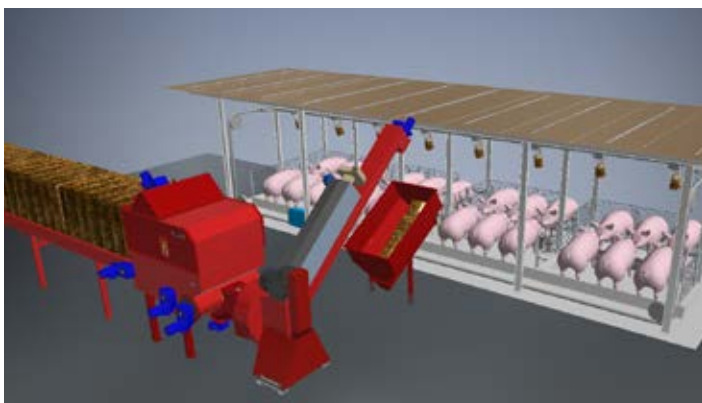

FUNKI MULTI STRAW

Straw distribution system for pigs and cattle



STRAW RIVET

- Different solutions
- Fully automatic
- Suitable for both big and round bales
- Simple and reliable
- Possible to use own straw
- Time saving
- Closed system that reduces dust nuisance

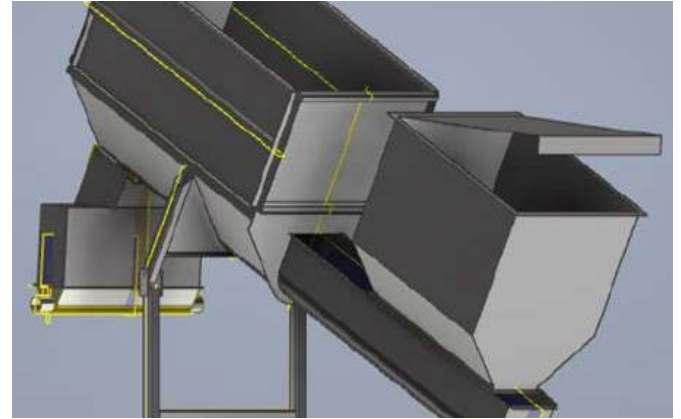

Solution with manual filling of container. It is simple and reliable. Suitable for filling with bedding, which is cut from external straw rivets and which can be purchased in sacks or loose.

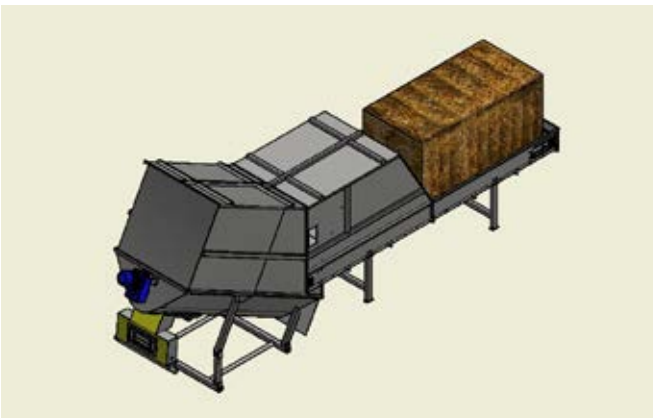

Automatic solution for prechopped big bales. It is well suited for filling with big bales, which are cut with a maximum length of 40 mm. Demolition and filling are done automatically. Band length can be increased as needed in stages of 2.5 meters.

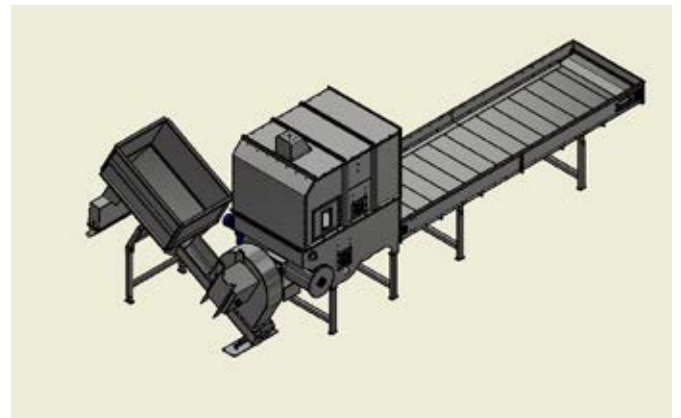

Automatic solution for big and round bales. There are built-in straw rivets, automatic tearing and filling. Here it is possible to use your own straw bales. Band length can be increased as needed in stages of 2.5 meters. Secured with sprinkler systems. NB: Cannot be used for sawdust.



Testimonials:

“ The straw systems calms the sows down, we avoid the rank fights that we experienced before.

We can clearly see the difference when the straw system is not running. ”

Morten, Operation Manager at Asger Krogsgaard Holding, Ringkøbing, Denmark
Full-line production, 2.600 sows



OUTDOOR DRY FEEDING

The way to good biosecurity

Placement of silos is a strategic decision that influences the entire setup. One of the points to consider is how far they are located from the building with the animals. If the trucks delivering feed to the silos get too close to the farm, there is a higher risk of infections.

The way to safeguard your investments:

- Reduce the risk of infections and diseases by placing the silos on a distance from the pig barn
- That way, no trucks get close to the farm
- It significantly reduces the risk of infections and improves biosecurity

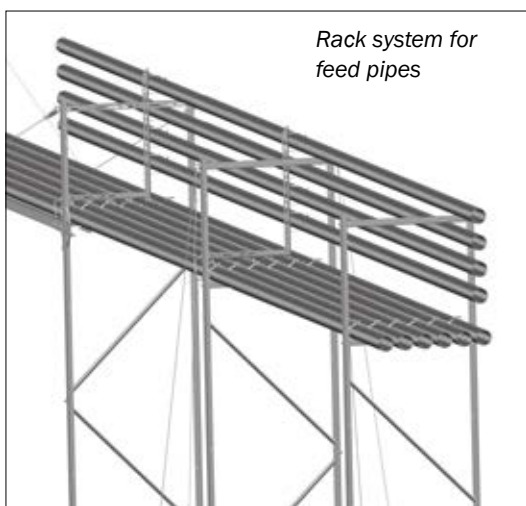
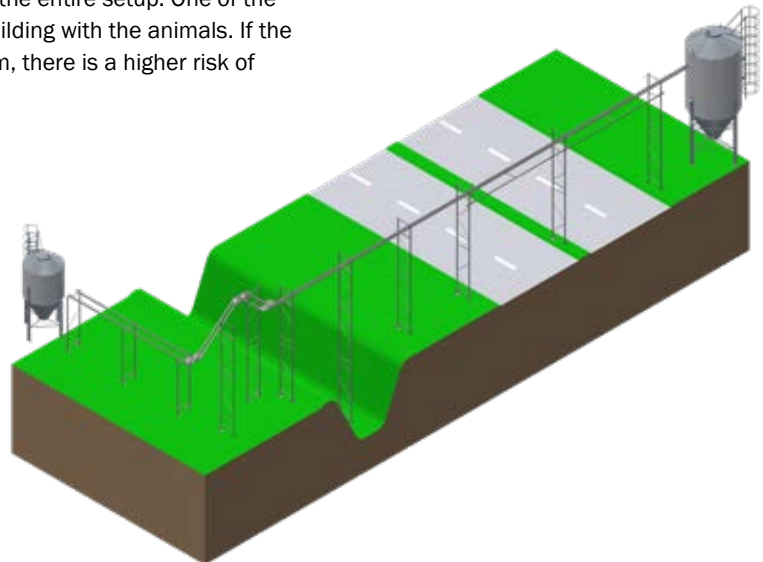

Rack system for feed pipes

- Our construction for outdoors dry feeding system is made of stable materials to ensure durability.
- All the materials are approved for outdoors use.
- The construction can be made in a height of up to 7 m, and can be placed above the roads or other obstacles between the farm and the silo.
- The construction can contain up to 10 pipes.

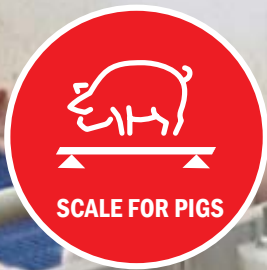

- Weighs 24/7
- Complete overview of pigs growth
- Helps to optimize the genetic potential
- Automatic feed regulation
- Optimal delivery weight
- Pigs growth curves day by day
- Connected directly to Funki MultiController

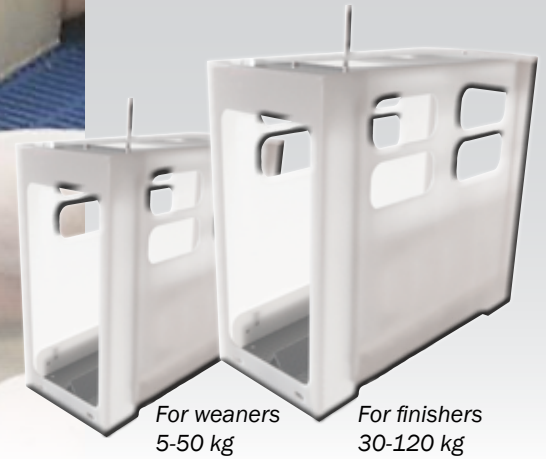

OPTISCALE

Accurate monitoring of pigs growth

Funki OptiScale ensures accurate monitoring of pigs growth. Our Funki OptiScale pig weight can be placed in a pen or between two pens.

The scale registers all the weighings during the day, and then send the feedback back to the feedings system, which can then be adjusted accordingly.

FOR WEANERS AND FINISHERS

Funki OptiScale is available in two models - one for weaners and a larger model for finishers. It can be placed anywhere in the pen and is attached to the floor. The scale detects if there is only one pig on the scale, and sorts the data if there are several pigs on it.



◀ GET OVERVIEW OF ALL YOUR DATA

You get all information about growth, feeding plan, slaughter data and the actual results directly to your mobile or PC.



This provides complete knowledge of your pigs' growth at any time of the day, and you can follow their growth day by day. This enables you to deliver all the pigs with the correct weight.



Testimonials:

“ It gives a lot of data, also how active they are, by the amount of weighings.

Data is the solution for all modern pig farms. This plays a crucial role in it.”

Farmer in Holland



ACO FUNKI CHAIN PROGRAM	
38 mm	400 kg/hour
50 mm	700 kg/hour
60 mm	1000 kg/hour
76 mm	2000 kg/hour
100 mm	6000 kg/hour
160 mm	21000 kg/hour

MASTER CHAIN + POWERLINE

Dry feeding system

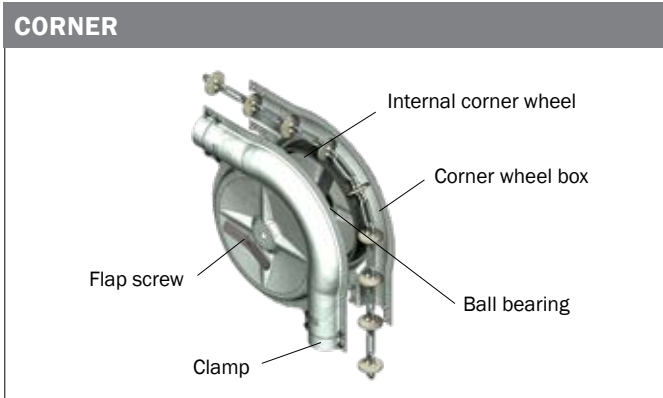

ACO FUNKI's corners are optimized for extra long durability

- No moist percolation or feed waste - deep drawn corner wheel boxes and weather strips that guarantee tight and strong corners
- Strength and durability - corner wheels in cast iron and with ball bearings
- Minimum risk of chain breakage - extra wide contact face
- Minimum risk of working interruptions - the spokes of the corner wheel are designed for the least resistance as possible and are applicable for one way as well as for reversible systems

Corners
For 38 mm system
Corner for 38 mm system
For 50 mm system
Corner for 50 mm system
For 60 mm system
Corner for 60 mm system - galvanized
Corner for 60 mm system - stainless steel
For 76 mm system
Corner for 76 mm system

300 metres chain and maximum 12 corners. For every corner less 10 metres of chain can be added. Likewise, 10 metres of chain is deducted for every corner added.

NB: There is a maximum of 24 corners per drive unit.

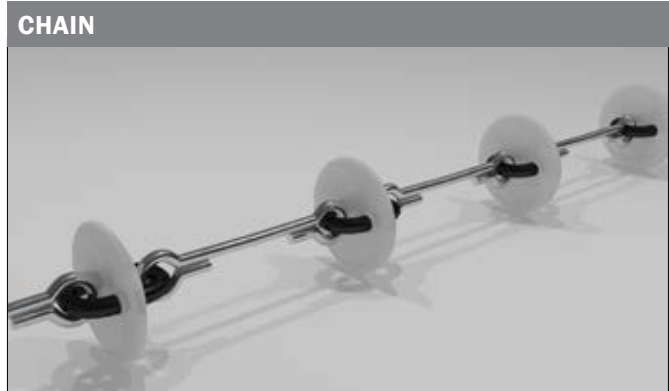

▲ POWERLINE® - extremely strong lightweight chain

- Strong and durable - PowerLine is made of two types of specially hardened steel that ensures long durability
- The PowerLine chain is quality tested between each joint - self-emptying drive unit that easily releases the chain



▲ MASTER CHAIN® ANTI-TWIST CHAIN

- Minimum wear and tear of the system, easy to mount
- The construction ensures minimum twist of the chain - optimized dependability
- Durable - hardened and galvanized. Nylon - very strong plastic material

ARTICLE No.	TYPE, MM	CAPACITY, KG/HOUR
MASTER CHAIN		
0170-049	60	800
86087	76	2000
POWERLINE		
0117-225	60	800

DRY FEEDING SYSTEM

Drive units and reception units

▼ DRIVE UNITS

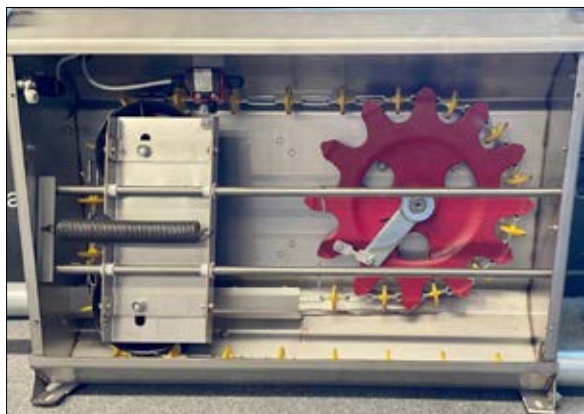

MAXI DRIVE UNIT

- for transportation of pellets and meal feed

- The drive unit is equipped with a large drive wheel that ensures stable and steady operation with minimal wear and tear on the plastic discs.
- The drive unit is equipped with a slanting, self-emptying base, which means that the amount of animal feed accumulating in the machine is very limited.
- The cabinet is made of stainless steel in a compact design that enables optimum fitting to a wall or directly onto the floor.
- The accompanying sight glass ensures that the filling ratio of the feed in the system can be optimally regulated.
- Easy to maintain. Standard motor, few parts that wear off.

▼ OUTDOOR INSTALLATIONS FOR DRY FEEDING SYSTEM



Plastic box for the drive unit outdoors



Protection for stop-sensor

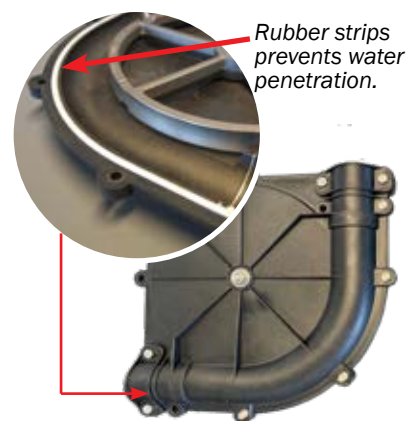

Rubber strips prevents water penetration.

Waterproof corner protection.

PROTECTION FROM SUN AND RAIN

The products have been developed to protect the important dry feed components against rain and sun and thus to extend the lifetime of the components.

▼ RECEPTION UNITS & CONNECTORS

Ø 38 / 50 / 60 / 76 mm



Reception unit - stainless or galvanized steel.

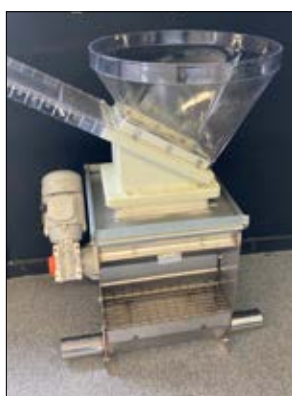

◀ LID FOR HOPPER U-60 L



◀ HOPPER U-150 L



◀ HOPPER U-60 L



◀ HOPPER U-20 L

▲ RECEPTION UNIT

The reception unit is the heart of the feeding system and is crucial to the dependability of the feeding system and the life span of the chain or wire. The reception unit controls how even and how much feed is dosed into the feed string.

ACO FUNKI's feeding system is also available for filling with flex auger.



◀ CONNECTOR

Ø38, Ø50, Ø60 and Ø70 with option for a shutter to open and close.



FLEX AUGER

For transportation of all feed types

Flex Auger is a transport system for delivering feed from a silo to a barn and for feed transportation inside the barn. The system is strong and reliable due to the stainless steel material and special construction.

The Flex Auger can be used along with a feed chain system or you can distribute feed directly by means of flex auger. The feed comes from the clear funnel under the silo.

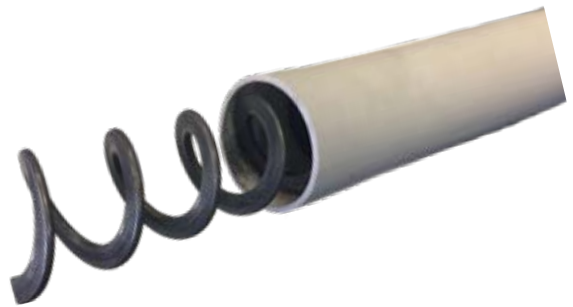

ACO FUNKI FLEX AUGER:

- **CAPACITY**
With Funki Flex Auger you can transport from 970 kg (Ø75) and up to 1850 kg (Ø90) feed per hour.
- **VARIOUS SOLUTIONS**
You can choose between single and double. Both options are available with either 75 mm or 90 mm.
- **OUTLET**
The standard funnel has two outlets, but the special solutions can have up to four outlets.
- **BIOSECURITY**
Flex Auger helps to keep trucks away from the houses, thus improving biosecurity on your farm.

FACTS

Max length	120 m with connection unit
Engine	1,5 kW, waterproof (IP66 approved)
If overload	Switch-off contact
Corner turns	90° with connection unit



TYPE	CAPACITY*
Ø 75	970 kg/h
Ø 90	1850 kg/h

* The capacity can vary depending on the length, amount of bends and feed type.

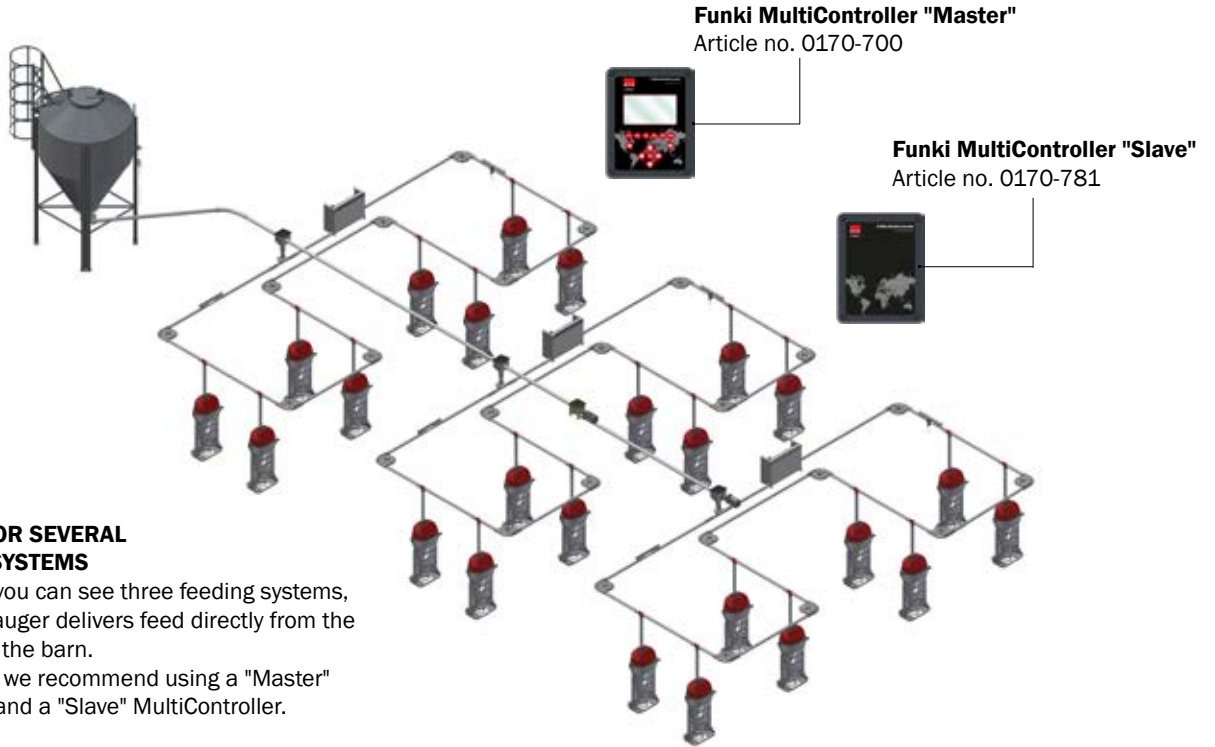

FLEX AUGER FOR SEVERAL DRY FEEDING SYSTEMS

In the drawing, you can see three feeding systems, where the Flex auger delivers feed directly from the silo and around the barn.

For this system, we recommend using a "Master" MultiController and a "Slave" MultiController.

SINGLE SYSTEM

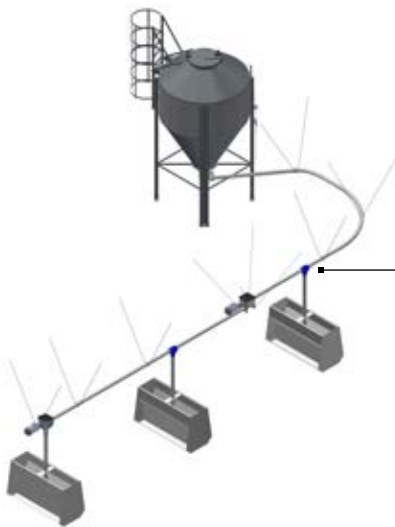

DOUBLE SYSTEM

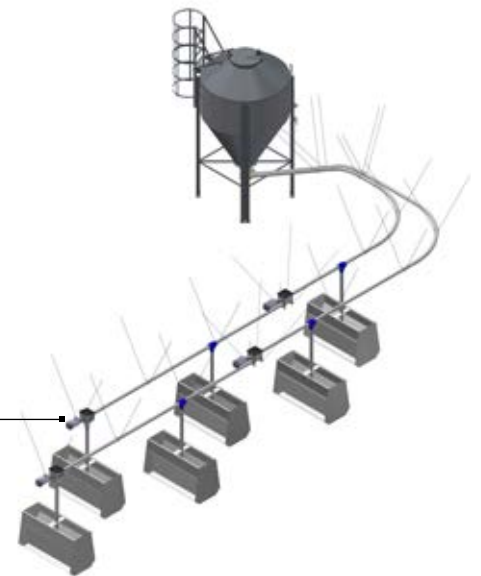

Flex auger can deliver feed directly into Box Feeders.

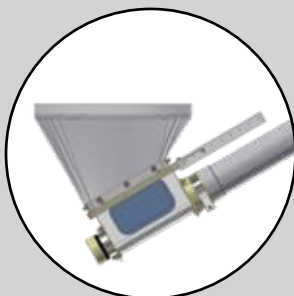

Inclined mounted position

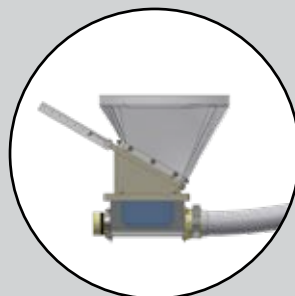

Horizontally mounted position



Funnel with double flex auger



FEEDERS

Different models for every age group



▲ FUNKIMAT



▲ TUBE-O-MAT



▲ TUBE-O-MAT NX



▲ TURBOMAX



▲ BOX FEEDER



▲ WET/DRY FEEDER

Robust construction

FUNKIMAT is made solely of stainless materials to ensure durability. FUNKIMAT is available in all models with pen sides of 1 m, suitable for installation options in the pen partition. Placing the feeder independently in the pen also is an option, when adding two posts.

Well thought-out details

The feed containers is designed to ensure optimum utilization of the volume and allows filling from low height. The container is waterproof for sprinkling and prepared for automatic filling from up to 3 feed circuits.



FUNKIMAT TROUGH

The trough is designed so that there is a good feeding space in the middle and easy access to water on both sides.



ADJUSTMENT HANDLE

The feeder can be adjusted for all types of feed, and it is possible to close the feed distribution completely.

- For weaners and finishers
- FUNKIMAT is one of our oldest and most popular models that has been tested for many years now and improved based on the farmers' feedback
- Easy to clean due to the smooth surfaces
- Water and feed are separated

FACTS

Capacity	SINGLE	DOUBLE
Hopper	100 L	200 L
No. of pigs per feeder	30-50	40-80
Frame		
Flat frame 40x3 mm, stainless steel		
Water supply		
1/2" stainless steel pipe with external thread		
Adjustable press nipple made of stainless steel		

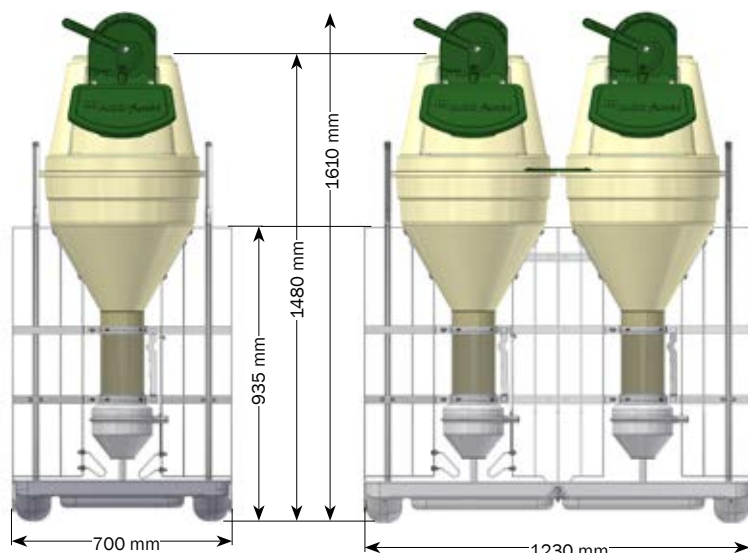

FUNKIMAT SINGLE

FUNKIMAT DOUBLE

Stainless steel trough - for FUNKIMAT DOUBLE

FUNKIMAT - WEANERS



FACTS

Weaners	5-30 kg
Trough height	100 mm
Pigs per trough	50-80

FUNKIMAT - FINISHERS

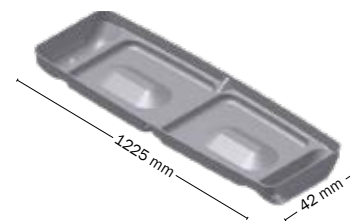

FACTS

Finishers	30-120 kg
Trough height	130 mm
Pigs per trough	40-70

FEEDERS

TUBE-O-MAT - the optimum feeder for all age groups



Reliable feed intake from day 1

The shielding is made of transparent plastic, which allows a maximum overview and easy control of the hygiene. It is easily opened without use of any tools. The dosing unit consists of very few parts which ensure a high level of hygiene and easy cleaning.

The activating part in stainless grille construction can easily be activated by the pigs and they quickly learn how to operate it. It ensures a reliable feed intake from day one.

Calm animals

The large opening and the integrated agitator ensure a constant feed flow and prevent bridging. The emergency closing system prevents feed waste.

User-friendly

All TUBE-O-MAT® feeders have hoppers and lids, developed with focus on maximum user-friendliness, easy cleaning, overview and space utilization. The choice of material - plastic and stainless steel - ensures long durability.

- Can be used for weaners, finishers and WEAN-TO-FINISH
- Strong construction in plastic and stainless steel
- Pigs learn to use the feeder from day 1
- The trough has double drinking bowls, so the pigs can choose water, dry feed or soaked feed
- The feeder ensures better animal welfare as the feeding principle satisfies the pigs' need to rummage
- Easy to operate for employees, and you can see the amount of feed in the hopper from a distance

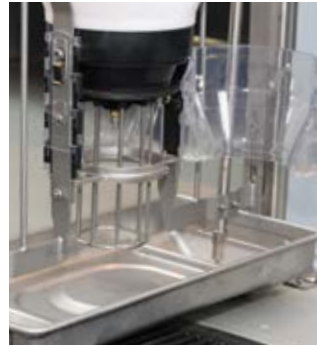

TUBE-O-MAT® VI+

The activating part on VI+ models is made of stainless steel and is designed for both piglets and finishers. Simple and very strong. The transparent lid can be opened for cleaning purposes.



TUBE-O-MAT® CLASSIC

Especially developed for finishers. It is supplied with an extra strengthened feed outlet, thus it can withstand the large pigs constant activation.

FACTS

Capacity	TUBE-O-MAT	TUBE-O-MAT JUMBO
Hopper	83 l / ca. 58 kg	160 l / ca. 112 kg
No. of pigs per feeder	30-50 (7-120 kg)	50-70 (7-120 kg)

Frame

TUBE-O-MAT® is delivered with frame of 4 mm stainless steel

Water supply

3/8" stainless steel pipe with external thread

Adjustable press nipple stainless steel

Stainless steel trough -

for TUBE-O-MAT VI+ and CLASSIC

VI+ / CLASSIC - WEAN-TO-FINISH	
FACTS	
WEAN-TO-FINISH	7-120 kg
Trough height	110 mm
Pigs per trough	30-50

VI+ / CLASSIC - WEAN-TO-FINISH	
FACTS	
WEAN-TO-FINISH	7-120 kg
Trough height	110 mm
Pigs per trough	50-70



TUBE-O-MAT



TUBE-O-MAT JUMBO

Meet pigs' need for rummaging

The feeding principle considers the natural manipulation behaviour, as the pigs have to activate the feeder to get feed. Consequently, the trough is cleaned and free of feed residues, which helps to keep a high level of hygiene.

Avoid bridging

The TUBE-O-MAT NX hopper is shaped with almost vertical sides to prevent bridging. The trough has double drinking bowls allowing the pigs to choose water or dry feed. Taking water and feed at the same time is also reducing stress in the group. You can measure the effect: excellent daily gain from wean to finish.



- For WEAN-TO-FINISH
- Extra large hopper (120 L feed volume)
- Always fresh water and feed
- Produced in Europe and made of high quality plastic, which ensures extremely long durability
- Minimum feed waste thanks to specially designed trough

FACTS

Capacity	NX V+ / NX CLASSIC
Hopper	120 liter
No. of pigs per feeder	50 (6-120 kg)

Frame

TUBE-O-MAT® NX is delivered with frame of 4 mm stainless steel

Water supply

3/8" r stainless steel pipe with external thread

Adjustable press nipple stainless steel

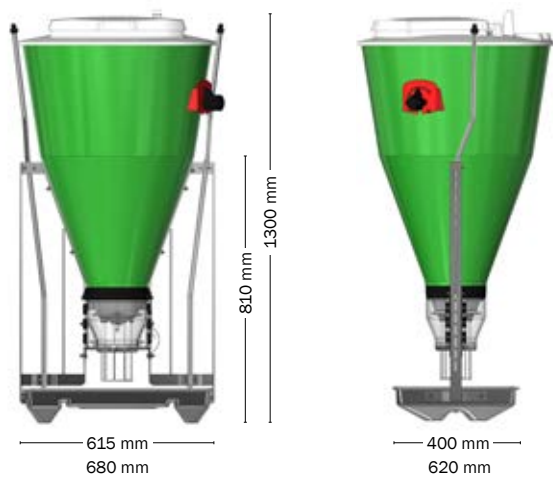

TUBE-O-MAT® NX V+

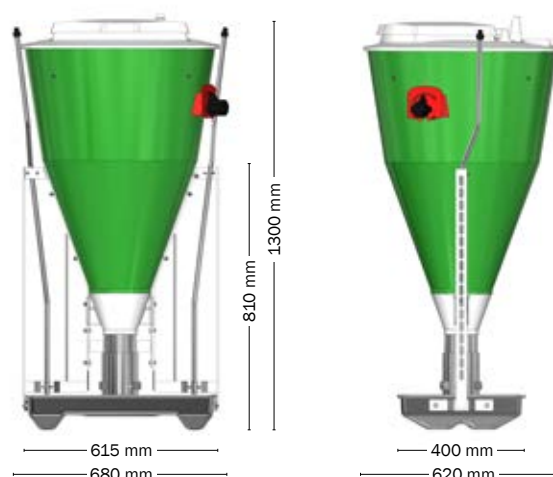

TUBE-O-MAT® NX CLASSIC

FEEDERS

TURBOMAX - fresh feed and water for pigs 7-120 kg



Less stress for animals

The TURBOMAX hopper is shaped to prevent bridging. The trough has double drinking bowls allowing the pigs to choose water or dry feed.

Taking water and feed at the same time is also reducing stress in the group. You can measure the effect: excellent daily gain from wean to finish.

Well thought-out trough and specially designed feeding function

- 3-part trough, which separates water and feed
- Intuitive to use for the pigs
- The pigs must activate the feeding themselves, thereby stimulating their activity needs
- Access to the trough from both sides of the feeder

- Up to 50 pigs per feeder
- For weaners, WEAN-TO-FINISH and finishers
- 100 L feed volume
- Perfect for both meal- and pellet feed
- Water and feed in one feeder
- Easy adjusting
- Minimum feed waste



◀ EASY SETTING AND QUICK ADJUSTMENT

- 15 settings allow for accurate dosing
- Can be adjusted so that the pigs get the optimal amount of feed
- You can see the settings on both sides of the feeder

FACTS

Capacity	TURBOMAX
Hopper	100 L
No. of weaners per feeder	30-50 (7-30 kg)
No. of finishers per feeder	30-50 (30-120 kg)
Frame	
TURBOMAX is delivered with frame of 4 mm stainless steel	
Water supply	
3/8" r stainless steel pipe with external thread	
Adjustable press nipple stainless steel	

Stainless steel trough - for TURBOMAX

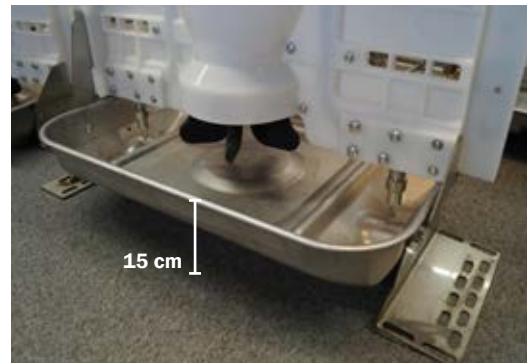

For finishers



For weaners

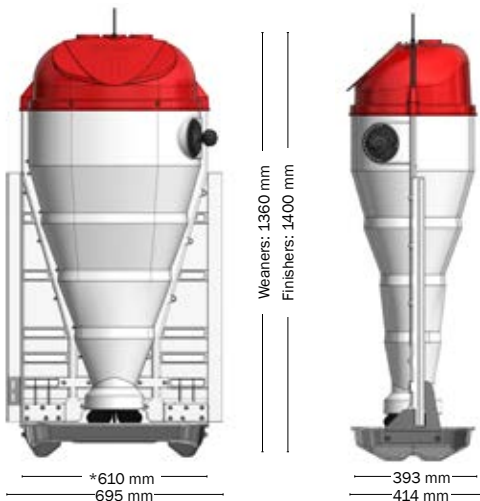

TURBOMAX

* Double: 1260 mm

BOX FEEDERS in plastic or stainless steel

- For weaners and finishers
- 20-120 pigs per feeder
- Easy access to feed
- No sharp edges
- Easy to clean
- Minimum feed waste
- Main frame is made of durable stainless steel
- Accurate multi-level adjustment
- Highly resistant against wear and tear



BOX FEEDERS IN PLASTIC - TYPE OVERVIEW

Description	Article no.*	Eating places	Width (cm)	Height (cm)	Depth (cm)
Weaners - Single	560042	2	41,5	74	31
	560043	3	61,5	74	31
	560044	4	81,5	74	31
	560045	5	101,5	74	31
	560046	6	121,5	74	31
Weaners - Double	560052	2	41,5	74	62
	560053	3	61,5	74	62
	560054	4	81,5	74	62
	560055	5	101,5	74	62
	560056	6	121,5	74	62
Finishers - Single	560062	2	61,5	99	39
	560063	3	91,5	99	39
	560064	4	120,5	99	39
	560065	5	151,5	99	39
Finishers - Double	560072	2	61,5	99	80
	560073	3	91,5	99	80
	560074	4	120,5	99	80
	560075	5	151,5	99	80

* Box Feeders can be delivered assembled (item no. + M) or unassembled (item no. + U).

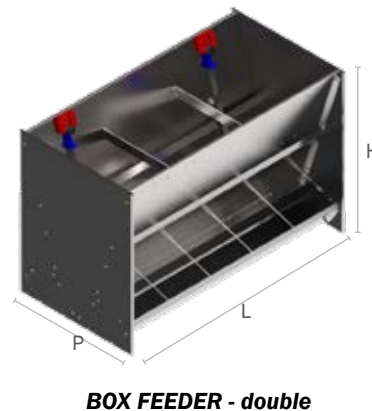
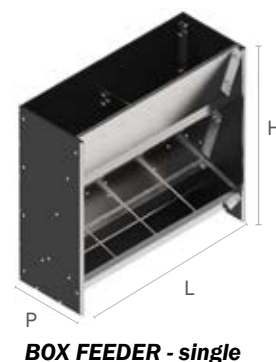

BOX FEEDERS IN STAINLESS STEEL - TYPES OVERVIEW

Description	Article no.	Eating places	Width (cm)	Height (cm)	Depth (cm)
Weaners - Single	560355	4	80	70	29
	560356	6	120	70	29
	560357	8	160	70	29
Weaners - Double	560360	4	80	70	47
	560361	6	120	70	47
	560362	8	160	70	47
WEAN-TO-FINISH - Single	560365	3	90	90	40,8
	560366	4	120	90	40,8
	560367	5	150	90	40,8
WEAN-TO-FINISH - Double	560370	3	90	90	73,5
	560371	4	120	90	73,5
	560372	5	150	90	73,5



FEEDERS

WET/DRY FEEDER



Mix of feed and water in the same trough

Wet-/dry feeders for Wean to Finish are available with features and options designed to meet the specifications and expectations of today's modern pork production systems.

The feeders are made of corrosion resistant 304 stainless steel and welded construction, these feeders are engineered for durability, ease of cleaning, simple management and superior feed conversion performance.

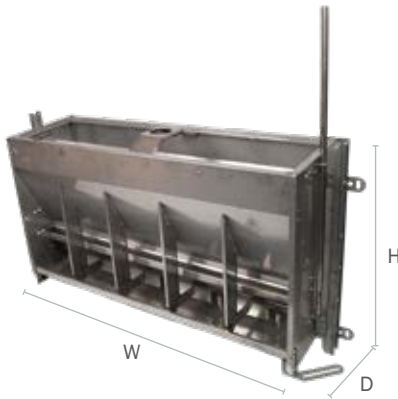

WET/DRY FEEDER - TYPE OVERVIEW

Description	Article no.	Eating places	Width (cm)	Height (cm)	Depth (cm)
Weaners - Double	560375	4	98	70	39,5
	560376	5	122,5	70	39,5
	560377	6	147	70	39,5
Finishers - Double	560380	2	76	90	51,5
	560382	3	114	90	51,5
	560384	4	152	90	51,5
	560386	5	190	90	51,5



Feed comes directly out of the drop-down pipe.



Water comes out of the press valves in the trough.



The adjustment system requires only two adjusters per feeder, providing quick, accurate and consistent control of feed gate settings.



The trough is equipped with dividers to separate eating places.



- The best start for pigs after weaning
- Increases feed and water intake
- Stimulate the piglets to eat and drink
- Ensures optimal growth
- Fills the trough when the sensor indicates it is empty
- Always fresh feed and water
- Easy to clean
- Reliable and easy to operate
- Adjustable pause time from emptying to feed assignment
- Possibility to adjust water volume
- The trough is designed for pigs from 4 kg
- Up to 60 pigs per feeder

BABY FEEDER®

Unique mix of feed and water. For pigs from 4 kg

Feeder with sensor

Baby Feeder is a feeder that can be used by even the smallest pigs from 4 kg. The unique design of the feeder makes it possible to mix feed and water inside the trough, which ensures better hygiene and cleanliness. Feed automatically fills when sensor indicates that the trough is empty.

Trough

Our Baby trough is long, and it makes it easy to build it between the partitions in a pen. The trough dimensions, front height and width are adjusted to the smallest pigs.



Feed automatically fills when sensor indicates the empty trough.

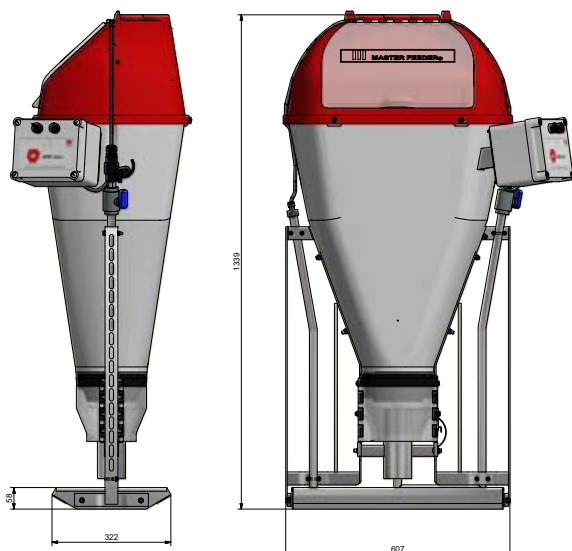

Water and feed are mixed in the bottom of the trough.

ACCESSORIES

Efficient and hygienic feed outlet for feeders



SINGLE DOWNPIPE



Y-MODEL



TELESCOP

Feed outlet

Feed outlet has a number of unique functional advantages ensuring effectivity and good hygiene.

Large capacity

The lower part of the outlet is oval and shaped in a way which makes it possible to drill more holes or cut a slot in the feed tube. This ensures a quick and effective draining of feed.

Always dry feed

The design of the feed outlet counteracts penetration of water and moisture.

Reliable slide

The slide fits tightly to the feed pipe, which prevents feed from accumulating which otherwise affect the function of the slide. The slide can easily be "remote controlled" by for example a broom stick, if it cannot be reached from the feeding passage.



◀ OUTLET SIZE:

38 / 60 mm

▶ OUTLET SIZE:

38 / 50 / 60 / 76 mm



▼ FLOOR PLATES FOR FEEDERS

Protects the floor and reduces feed waste

Floor plates for feeders

We recommend using a plate under the feeders. This helps to protect the floor from corrosion from the feed while avoiding too much of the feed spilled down through the slots in the floor. The plates have a non-slip structure in the surface.



SINGLE FUNKIMAT & 3IN1 ROTO
10 x 670 x 1200 mm (Article no.: 0227-559)

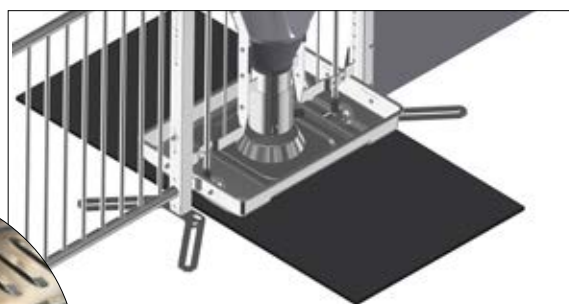

SINGLE TUBE-O-MAT
10 x 608 x 1200 mm (Article no.: 89014)



DOUBLE FUNKIMAT & 3IN1 ROTO
10 x 1200 x 1200 mm (Article no.: 0227-558)

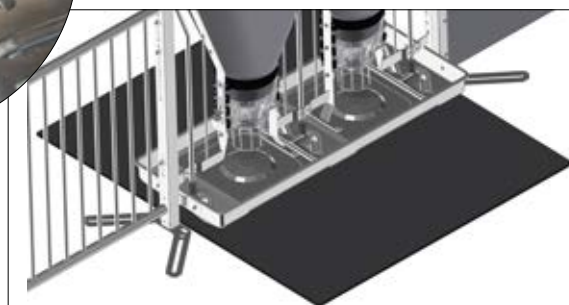

DOUBLE TUBE-O-MAT
10 x 1040 x 1200 mm (Article no.: 89016)



ISF - INTELLIGENT SOW FEEDING

COMPACT FEEDER - Strategic feeding for lactating sows

- Ad libitum feed with increase feed intake
- Early identification of lactating sows with low feed intake
- Trigger behavior (activity pattern)
- The sow gets an automated “appetizer”
- Can be easily added to any conventional dry-feed system
- Individual feeding strategy throughout day and night (real-time)
- Minimal loss of sow’s body condition
- No cleaning troughs and waste feed
- Always fresh and palatable feed



◀ ACTIVATOR

A sensor that detects if farrowing sows are activ. Fully automated and demand-driven by the sow (still slow/small portions).



◀ SENSOR IN THE TROUGH

When the sow activates the sensor, it sends the signal to the Compact Feeder. The feed is being released after the signal.



◀ OPENING FOR ADDITIVES AND VITAMINS

The hopper is designed with an extra opening. It allows you to add medicine and vitamins into the feed when necessary.

AD-LIB FEEDER

Almost two more piglets per litter



- Ad libitum feeder for lactating sows
- Sow can decide for herself how much she would like to consume from day 1 to weaning.
- Sow can mix feed and water without bridging
- Volume 7 l
- Higher feed intake
- Higher water intake and milk yield
- Higher weight at weaning
- More live born piglets in the next litter

PERFORMANCE PER LITTER

A two-year trial by the University of Guelph (USA) showed a 1.7 piglets per litter increase in subsequent litters for lactating sows using free choice feeders versus other lactating sow feeding methods. The research showed that there are significant benefits to having feed and water in one feeder.



▲ SETTINGS

With Ad-lib feeder, the feed dosing can be adjusted according to one of three levels.

COMBI-FEEDER

Weaning in the farrowing pen

- Can be used for both nursing sows and weaned pigs
- Pigs stay in the familiar environment up to 30 kg
- After lactation the sow is moved while the pigs stay in the pen until 30kg. This is supported by COMBI-FEEDER which can be adjusted manually
- During lactation, the feed is dosed via a mounted feed dispenser
- When the sow is moved, the pigs are fed ad libitum
- Lower costs, as pigs use the same feeding system

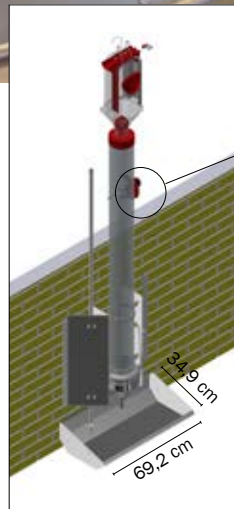

- 50 g higher weight gain for piglets
- Lower costs, as pigs use the same feeding system
- No additional zink in the feed mix
- Save a wash as the weaners stay in the farrowing pen



▲ Feeder with pendulum for feeding of the weaned pigs



▲ Feeder without pendulum for feeding of sows

FACTS

Article no.	0227-495
Width - mounted, mm	656,7
Height under feeder, mm	1781,5

VD100 FLOOR FEEDER

Efficient floor feeding for all age groups



VD100 FLOOR FEEDER

The feeder is specially designed for floor feeding of gestating sows, but can be used for all age groups. It is a simple and effective feeding method.

We recommend group size of min. 12-15 sows per pen, but the feeder can also be used for larger flocks of up to 50 sows per pen. It is recommended, that pigs are divided into 3 teams incl. gilts, and by applying immediately after mating in minimum 4 teams. Sorting of the sows is made according to condition and age.



FACTS

Article no.	0223-240
Width/length ratio	2/3 - 2/4
Volume	40 l
Feeding area	1,3 m ² /sow

SIMPLE PRINCIPLE

The feeder is mounted with 2 feed lines with feed dispensers or 1 string with floor feeder for maximum spread of the feed. The floor feeder must be able to accommodate the entire feed amount when all the sows are at the highest feeding intensity (4 FU per sow per day is equal to 7 liters per sow).

▼ SCRAPER SYSTEM

A simple and efficient solution with long durability

- When using straw bedding, the scraper system is a simple and inexpensive solution to get the straw out of the channels again
- Reduces ammonia and odor emissions
- Minimum maintenance costs
- No limitation on straw length
- Benefits of environmental applications

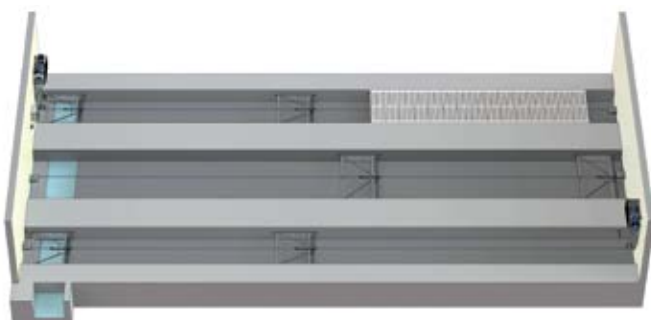
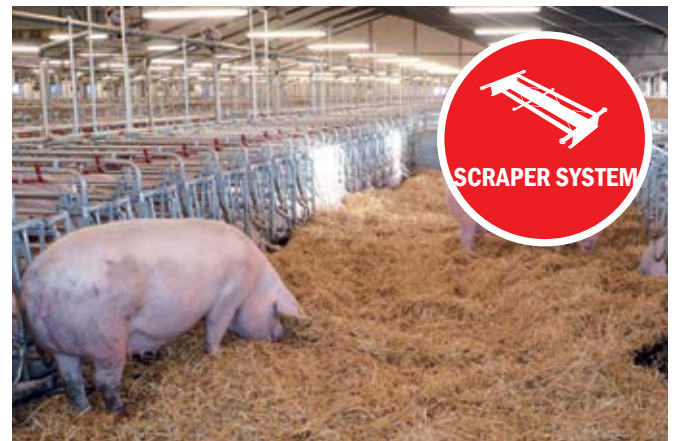

SCRAPER ►

A particularly simple scraper with few moving parts.

Scraper height: 30 cm

Scraper width:
channel width minus 4 cm

Types: 100-150 cm, 150-200 cm and 200-250 cm.



**Capacity
6/8/10 L**



- Exact dosage of feed amount
- Can handle two types of feed mixes at a time
- Adjustable feed amount down to 0.2 kg
- Detachable bottom hopper
- No bridging
- Easy to clean
- Simple design
- Competitive price
- The bottom hopper can be mounted in 4 positions

VD2 + VD22 FEED DISPENSERS

2 feed mixes for sows

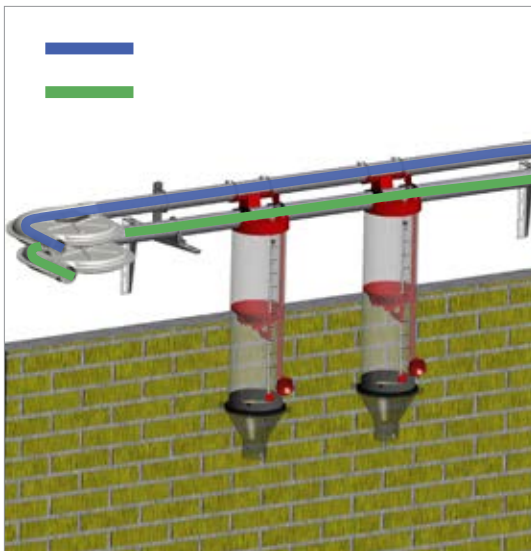

VD2 FEED DISPENSER



VD22 FEED DISPENSER



75 mm outlet

- Ø 60 - 6 L
- Ø 60 - 8 L
- Ø 60 - 10 L

Can be used on Ø38, Ø50 or Ø55 feed pipe with adapter

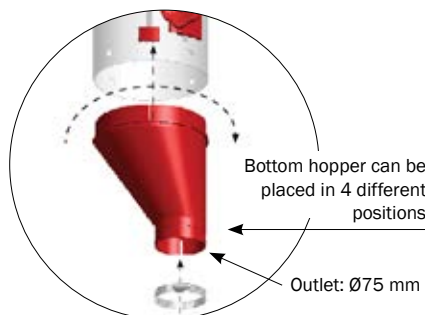
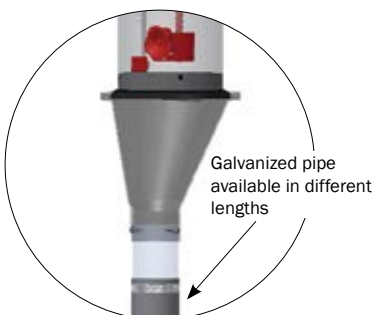

◀ **BOTTOM HOPPER**

Made of plastic. Central or asymmetrical design.



▲ **TURN BUCKLE FOR EASY ADJUSTMENT**

Precise and easy dosage of feed.

- Easy to clean, good hygiene
- Minimum maintenance
- Made in transparent plastic - exact overview of the feed amount
- Easy allocation of nutritional supplements and medication
- Suitable for flour or pellet feed
- Easy and efficient cleaning of feed downpipe
- Ventilation of the feed pipe via the funnel - minimizes moisture formation



VD5 + VD6 FEED DISPENSERS

Many combinations. Simple design



◀ VD5 FEED DISPENSER 75 mm outlet

- Ø 38 - 8 L
- Ø 50 - 8 L
- Ø 55 - 8 L
- Ø 60 - 8 L
- Ø 75 - 8 L

- Asymmetrical hopper prevents bridging
- Large lid and removable funnel for easy cleaning
- The volume is easily adjusted with a slide pushed up / down
- Can be adjusted with feed in the feed dispenser
- The ball ensures that the feed is released at a controlled rate
- Ability to reduce feed inlet down to 0.90 liters

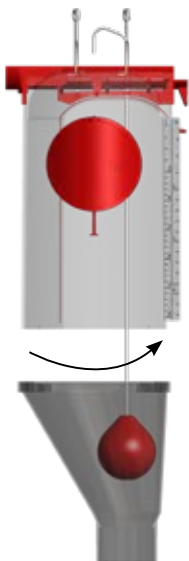

▲ DETACHABLE HOPPER

Central or asymmetrical design.



▲ LARGE CLEANING OPENING

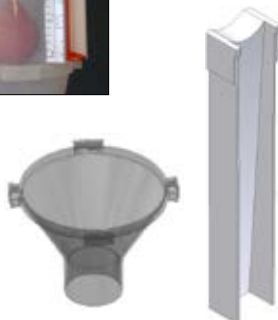

▲ REDUCTION

With reduction inlet and/or hopper.



◀ VD6 FEED DISPENSER 75 mm outlet

- Ø 60 - 6 L with flap

- No bridging
- Two lids for inspection (top and bottom)
- Can be adjusted with feed in the feed dispenser
- Locking function allows to omit feeding from a single place
- The bottom hopper can be set in 4 positions



▲ LOCK-FUNCTION



▶ TWO INSPECTION LIDS

EQUIPMENT FOR MATING & GESTATION

With our mating and gestation boxes, you are sure that function and quality meet your requirements.



LD-BOX



FREE ACCESS BOX



ELECTRONIC SOW FEEDING

▼ FREE ACCESS STALL

Combined mating and gestation unit



- Open stall with plenty of space for the sows
- Top hinged rear gate - ensures easy access to sows
- Optimum space utilization
- Suitable as a mating stall
- Easy inspection, scanning and treatment of the animals gives better production and less time consuming
- Can be adapted to all floor types with multi-adjustable foot bracket

FACTS

Stall length	2340/2100 mm
Lying length	2000/2100 mm (w. front grille extension)
Height	1033 mm
Width	600/650/700 mm
Posts	40 x 40 x 4 mm
Rear support	25 mm solid cast iron
Horizontal pipe	33,7 x 2,65 mm
Front gate/rear gate	Side hinged/ top hinged
Locking system	Integrated into the stall side
Quality type	Hot galvanized
Water supply	1" galvanized or stainless steel pipes
Water inlet	½" SS pipe, SS nipple. 1 per 2 boxes

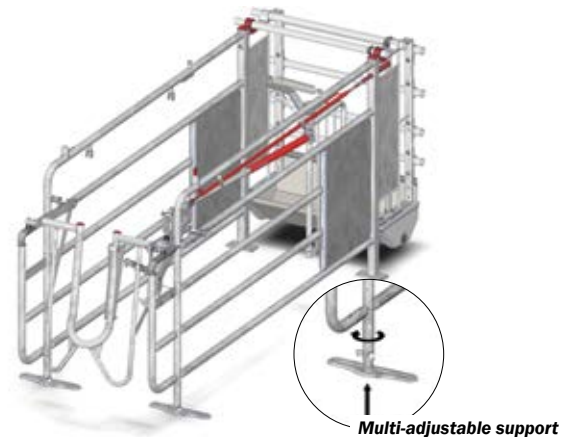

▼ LD STALL

Traditional mating stall



- Easy access and good space ratio for sow as well as staff
- Ensures optimum stimulation and time of service
- The side covered trough gives an undisturbed eating situation and thereby a low stress level
- The open front grille/front gate provides a superior boar contact and ensures clear heat symptoms
- Rounded equipment parts and focus on finish to minimize the risk of injuries
- Multi-adjustable foot bracket

FACTS

Stall length	2680/2780 mm
Lying length	1900/2000 mm (w. front grille extension)
Height	2000 mm
Width	650 mm
Posts	40 x 40 x 4 mm
Horizontal pipes	33,7 x 2,65 mm
Bars	14 mm solid round iron
Front/reargate	Side hinged
Locking system	2 meter height
Quality	Hot galvanized
Water supply	2 meter height: 1" galvanized or stainless steel
Water inlet	½" SS pipe, SS nipple. 1 per 2 boxes



▼ JUMB-O-FINE BOX

For weaning and gestating sows



JUMB-O-FINE is a box for weaning and gestating sows. Free access to the sow due to the unique Duo rear gate. There are no upper pipes which means free access to the sow throughout the length of the box.

Simple locking system without loose pins. Extra strong box construction. Multi-adjustable support.

FACTS

Box length	2330 - 2470 mm
Lying length	1900 / 2000 mm (w. front grille extension)
Height	1100 mm
Width	Variable 550 - 750 mm
Posts	40 x 40 x 3 mm
Upper pipe	33,7 x 2,65 mm
Lower pipe	42,5 x 2,65 mm
Bars	14 mm solid round iron / 12 mm in the back
Rear gate	Duo gate box width 620-700 mm / 710-780 mm
Quality	Hot galvanized
Water supply	High piping PVC / low piping SS
Water inlet	½" SS pipe, SS nipple. 1 per 2 boxes



▼ CONFINE BOX

Mating stall with simple and practical design

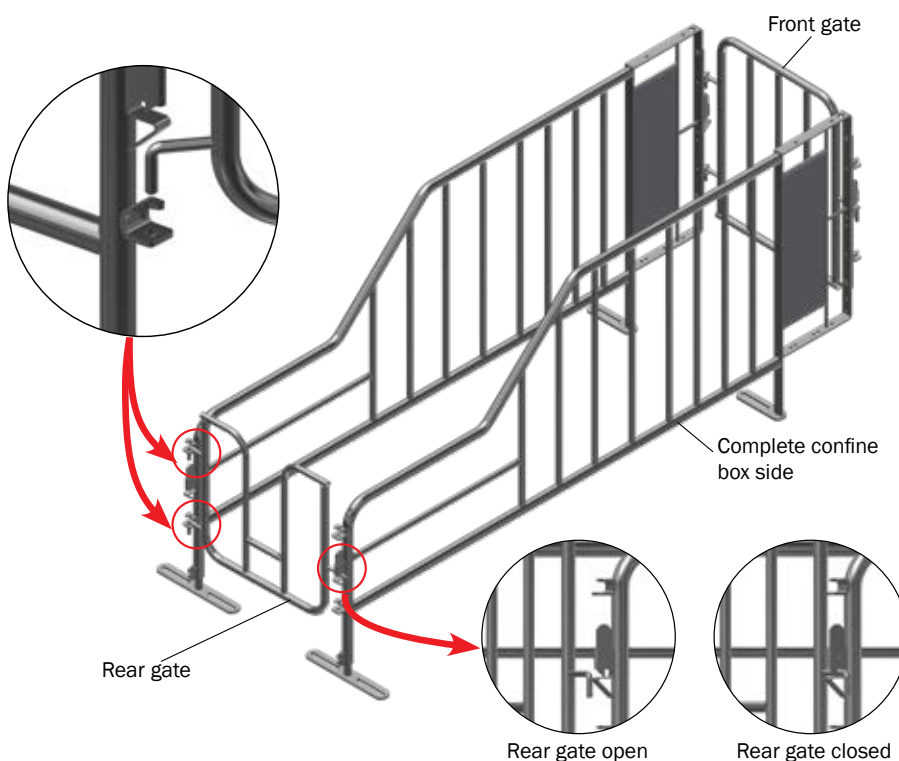

- Front part with front pipes or front gate
- Available with suspended stainless steel or polymer trough
- No upper pipes which means free access to the sow
- Strong construction

FACTS

Length	2279 / 2364 mm
Height	995 mm
Width	650 mm

▼ BOAR DOOR WITH DISTANCE CONTROLLED HANDLE

For easier insemination process

This special boar door is designed in order to make the insemination process easier. Thanks to the long handle, the door can be opened from the distance, without entering the mating box.

To ensure long durability, the door can only be opened in one direction, as the lock stop is mounted (optional right or left).

It makes it easier to slam the door, when the boar has passed.

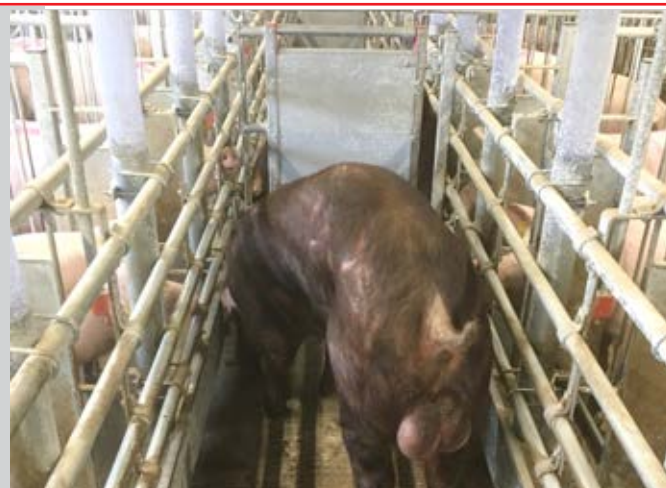

BOAR DOOR

Description

Assembled boar gate H110 for Jumb-O-Fine, Free Access, Multi Comfort and LD-box

Set for boar gate Jumb-O-Fine and LD-box with front pipe, aisle width 70-105 cm

Mounting kit for concrete floor with 2 bolts

Mounting kit for slats with 2 anchors and bolts

Boar door adjusted on site

BLOCKING GATES AND HINGE BRACKETS

CLEAN-O-FLEX®

- Easy to learn for the sow
- Strong and stable
- Simple and reliable
- Easy to assemble
- Work-friendly
- Timesaving
- Various sizes



Single hinged

Height 75/100 cm

- Easy access with pin lock
- One-hand operated
- Opens and closes at bracketside
- Available in widths up to 250 cm

BARRIER GATES - SINGLE HINGED	
Height (cm)	Width (cm)
75 / 100	Max 120
75 / 100	Max 170
75 / 100	Max 220
75 / 100	30-250

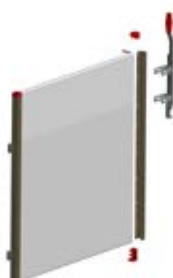

Double hinged

Height 75/100 cm

- Fastened in both sides
- Opens and closes at both sides
- Can be moved to other positions
- Reversible

BARRIER GATES - DOUBLE HINGED	
Height (cm)	Description
75	Board profile, reversible
100	Board profile, reversible





ESF - ELECTRONIC SOW FEEDING

Transponder - Individual feeding in small and big groups

Automatically provide each sow in the group with the right amount of feed? Electronic Sow Feeding (ESF) can do just that.

Each sow can take her individual ration of feed here, in a safe and comfortable environment. That means that with less work, you can keep the sows in top condition. This is Important in order to achieve more live born piglets, fewer returns and fewer leg problems.



With ESF, you can ensure each sow gets the individual feed and care she needs, as well as the benefits of being in a calm gestation group.

We can offer the automated feeding concept into any size operation, including new or remodeled buildings. ESF can help you eliminate feed waste and optimize whole-herd feed efficiency. With accurate data at your fingertips, you can set feed plans for each sow.

The system automatically adjusts diets, and your sows stay in optimal body condition.

The system is designed with the sow's needs in mind. It allows each sow to eat safely, without interruption and walk forward, away from the group, when she's finished.

The unique design of group sow gestation pens with ESF keeps sows calm and supports a productive atmosphere.

The design incorporates feed-stations with forward-exits, which has been proven for decades to minimize sow injury and stress by separating fed and unfed sows.

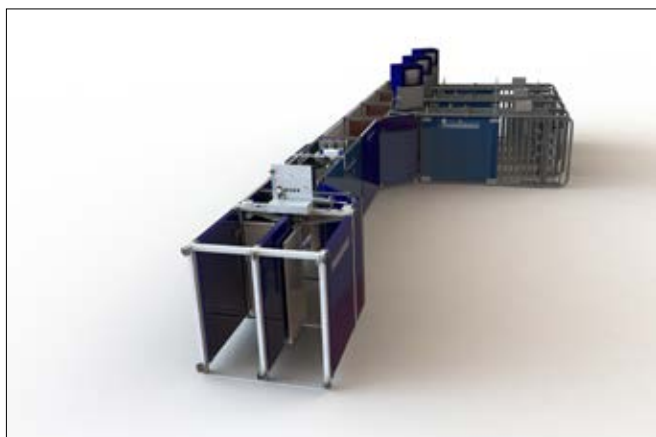

ACCESSORIES FOR MATING STALLS

LED-light and automatical stimulation of sows

▼ INN-O-LED "PLUG 'N' PLAY"

The right lighting in your barn is important for optimum pig production. The INN-O LED moves the light into the sows' living zone, which gives better light. The INN-O LED is easy and affordable to use in everyday with a smart click fitting. The LED luminaires are series-connected and modular. The installation can be done by the pig farmer with a Plug 'n' Play cable.

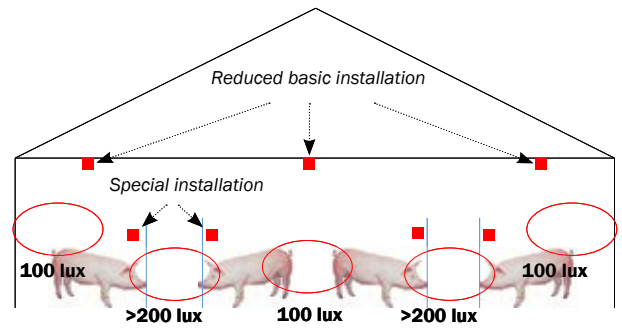

IMPORTANCE OF LIGHT

Mating & Gestation unit

- Light has an effect on excretion of estrogen
- 3% higher farrowing percentage
- Avoid autumn crashes

Farrowing unit

- +0.5 more born piglets per litter
- More light to sows, gives increased milk yield
- Higher weight at weaning after switching to LED

Piglet nest

- The goal is to attract the piglets into the piglet nest
- The light is yellow (2700 Kelvin) - it is visible to piglets

Economy

- Energy saving up to 60-80% compared to ordinary light
- Return on investment: 3 months

EL-SAVINGS
60-80%

► FULLY AUTOMATICAL STIMULATION OF SOWS

Fully automatical stimulation of sows in connection with insemination. The stimulation takes place in two stages - in two programs.

The first program starts automatically when Stimulus is turned on - this program makes the first coarse stimulation of the sow.

Stimulus performs heavy pressure on the back and in the loin area. Like the boar would have done, if it had the task.



STIMULUS

Article no.	Description
560520	STIMULUS
560521	MULTIHOLDER FOR STIMULUS



INN-O-FLEX

Penning equipment for sows and boars

INN-O-FLEX is a flexible penning program for sows and boars. The equipment is 110 cm high and mounted on 5x5 cm galvanized posts. Both 35 mm and 40 mm board profiles as well as 10 mm solid panels can be used.

There are vertical or horizontal pipes at the top of the equipment, that close tightly over the board profiles. Likewise, stainless steel U-profiles with inwards curved edges reduce the risk of manure penetration between U-profiles and board profiles. It ensures a better durability and makes it easier to keep the equipment clean.

FACTS

Height	110 cm
Posts	5 x 5 cm galvanized
U-profiles	1,5 mm SS steel
Bars	33,7 x 2,65 mm hot galvanized
Thickness:	
PVC board profile	35 / 40 mm
Fiber plate	10 mm
Steel plate	2 mm
Gate handle	
Twistlock	For 10, 35, 40 mm
Pinlock	For all types of INN-O-FLEX equipment



◀ COLLECTION PEN FOR BOARS

- Easy passage
- Can be used as separation between the pens to sows
- Good overview
- Quick exit
- Security for the employees

PARTITION IN THE TAPING DEPARTMENT

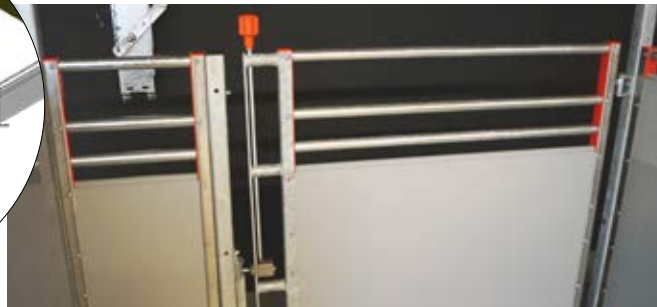
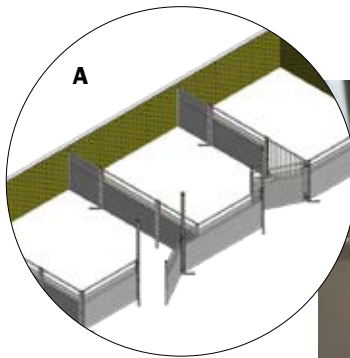

A: 35 MM PVC BOARD PROFILE
- H 110 CM

- Flexible
- Easy to adjust on site
- Strong 50 mm posts
- Recommended for gilts and young females

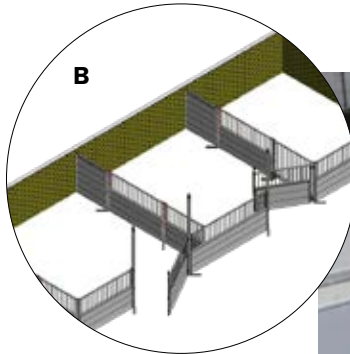

B: 40 MM PVC BOARD PROFILE
- H 110 CM

- Very durable
- Twice as rigid as 35 mm
- Strong 50 mm posts
- Recommended for gilts and young females

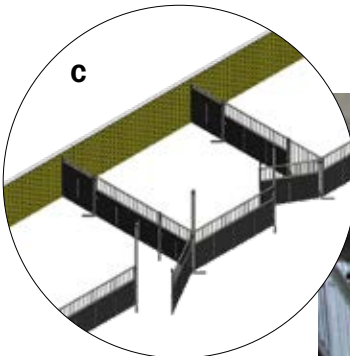

C: 10 MM SOLID PANEL
- H 110 CM

- Space efficient
- Very stable
- Strong 50 mm posts
- Fully welded equipment
- Recommended for boars and sows

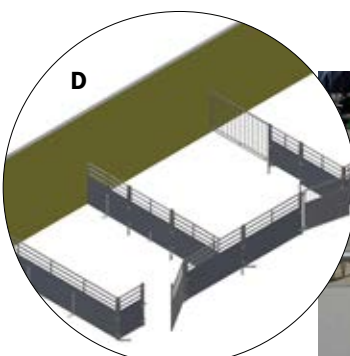

D: 10 MM FIBRE PLATE
- H 110 CM

- Smooth surface
- Impact resistant fibre plates
- Strong 50 mm posts
- Recommended for boars and sows

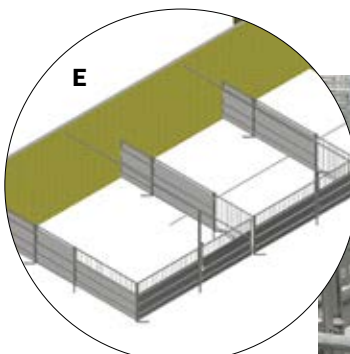

E: STEEL PLATE
- H 110 CM

- Strong 50 mm posts
- Recommended for boars and sows

FARROWING

With many years of experience, ACO FUNKI brings you to the top with high quality equipment. You can find traditional farrowing pens, extra large crates and multi-adjustable crates.

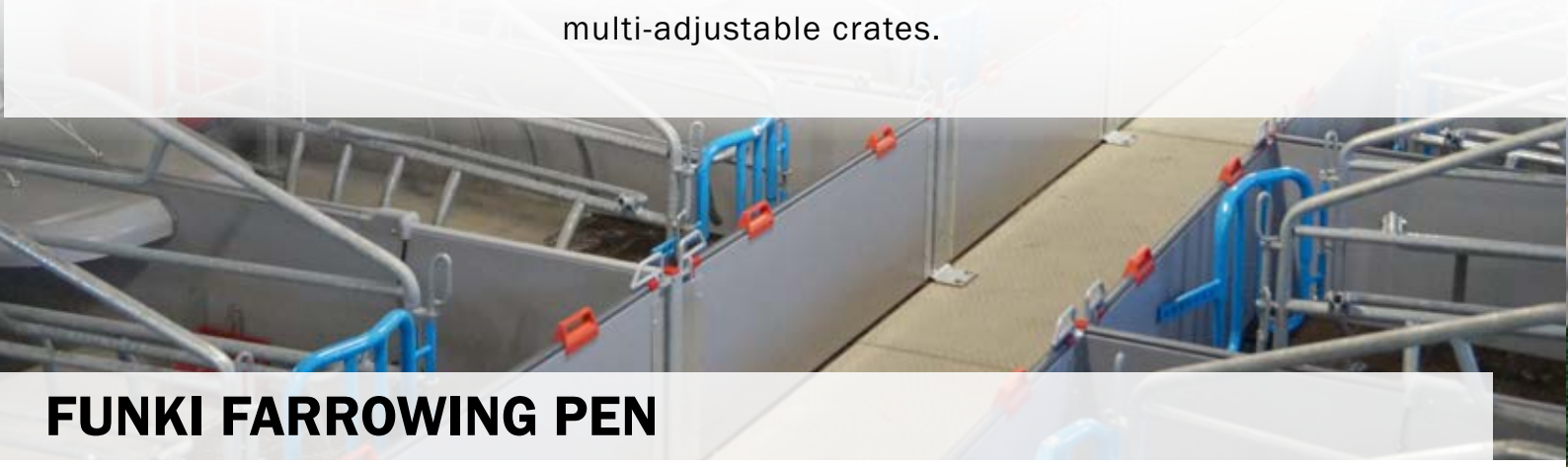

FUNKI FARROWING PEN



INN-O-CRATE FARROWING PEN



WELSAFE FARROWING PEN FOR LOOSE SOWS



WELSAFE

Space-saving farrowing pen for loose sows.
Higher weight at weaning

FOCUS ON ANIMAL WELFARE

Welsafe farrowing pen is designed to ensure the best conditions for both sows and piglets. The pen is designed in a way to ensure the warmer space for the piglets and cooler space for the sow.

The WELSAFE farrowing pen is equipped with a swivelling sides on both sides of the sow. The sides are flexible to achieve comfort for the sow, they keep her in place during and after farrowing. When the sow wants to lie down, the sides help to prevent the piglets from being crushed.



The WELSAFE unique features help reducing piglet mortality and improving weaning weight compared to a traditional farrowing pen. The WELSAFE farrowing pen is space-optimized and can be installed in old as well as new stables.

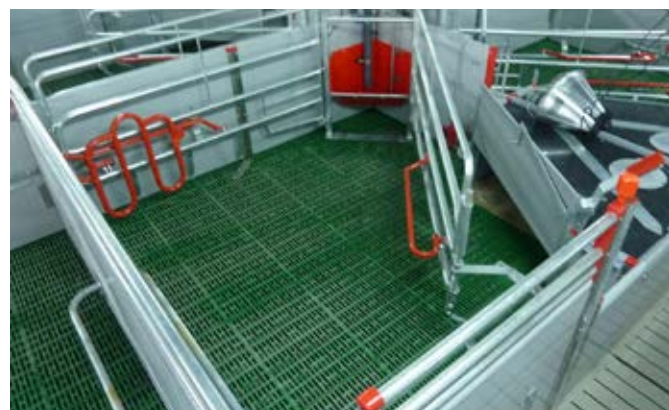

WELSAFE

Smart alternative to traditional farrowing



PRODUCTION RESULTS

- +0,5-1,0 kg higher weight at weaning
- More piglets per litter
- Lower mortality rate compared to traditional farrowing
- Stronger sows in better condition
- Lower consumption of antibiotic
- Better animal welfare

CHANGES ARE COMING - BE AT THE FOREFRONT

In the last two decades, in many countries and production systems all across the globe gestation crates have disappeared to enhance sow welfare. The notion grows that also during lactation a sow must also be able to stretch her legs.

In various countries, legislation has already been accepted in that direction, and it is likely new farrowing crates will have to change design and usage in the European Union by latest 2027. Plenty of reasons therefore to look into alternatives already now.

ACO FUNKI has developed WELSAFE farrowing pen for loose sows, where the sow is only confined for a few days and has better conditions compared to a traditional farrowing pen.

When the piglets are born, they are safe right after birth, while the sow is still confined. After this, they have plenty of space to move around.

Testimonials:



I have chosen Welsafe farrowing pens because of its simple management and innovative design.

There are two temperature zones - one for the sow and another one for the piglets. With this system, I have a lower mortality rate."

Blandine et Jean Marc, Cotes D'Armor, France



It was very important to us to embrace the future and new technologies. We had already worked with ACO Funki before, and we are very pleased with their free access boxes.

After moving from the old pig house to the new one, I can easily say that our pigs are happier. You can see it at first glance. They feel comfortable, at ease, simply well.

*Dziwinski farm, Poland
1500 sows*

WELSAFE FARROWING PEN FOR LOOSE SOWS

Better weaning weight and animal welfare

WELSAFE DIMENSIONS

There are several options with the WELSAFE farrowing pen:

	Total surface, m ²	Total available surface, m ²	Total available surface, %	Diameter, m
A	5,76	3,90	68%	1,80
B	6,25	4,40	71%	1,85
C	6,76	4,60	68%	1,90
D	5,60	3,65	65%	1,75
E	6,24	4,15	67%	1,80
F	6,63	4,30	65%	1,80
G	6,50	4,15	63%	1,87
H	5,76	3,65	64%	1,65

■ Optimal use of Welsafe farrowing pen

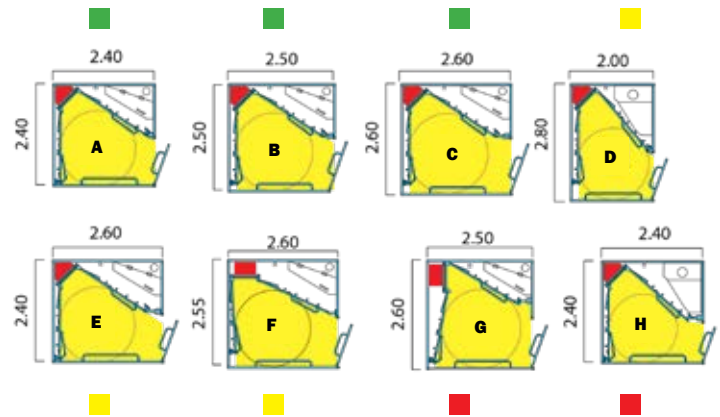

◀ INSPECTION ACCESS

Good space between farrowing box and piglet nest gives inspection access, so that it is not necessary for employees to come in to the sow.

The distance between farrowing box and piglet nest can be adjusted by means of the special fitting.



▲ SPACIOUS

There is plenty of room for both the sow and the piglets in the Welsafe farrowing pen. Good conditions for the animals help to increase productivity and production results.

▼ PIGLET NEST

Warm and cozy place for the piglets. Available as standard model (0,75 m²) or as XL model (1 m²).



PVC BOARD PROFILE



FIBER

WELSAFE "MOVE" MODEL

Allows to fix the sow in the easiest, fastest and safest way

WELSAFE "MOVE" is a special model that allows to temporary fixate a sow without walking into the sow's area. It is a good way to avoid injuries for the employees and the sows.

There is a special gate that allows you to not get in direct contact with the sow.

The time when the sow is not fixated, it can walk free inside the pen, just as in the regular pen for loose sows.

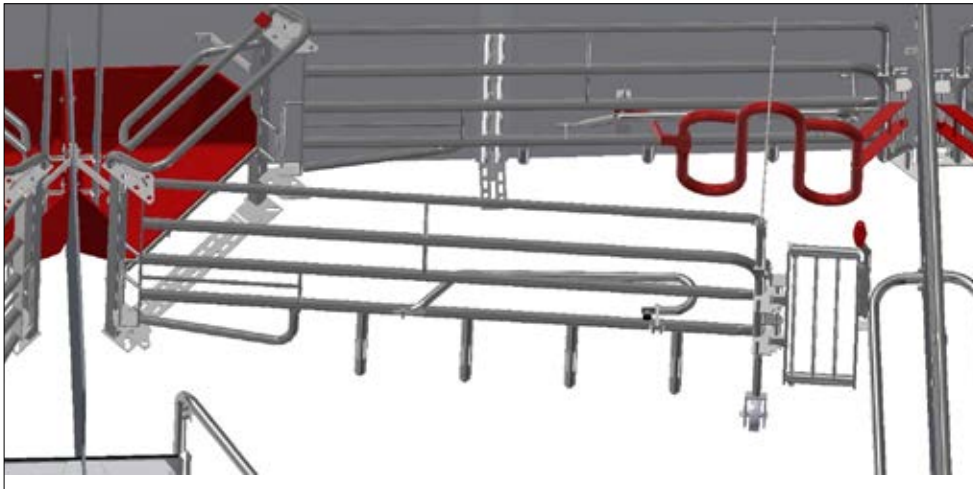

WELSAFE "MOVE"

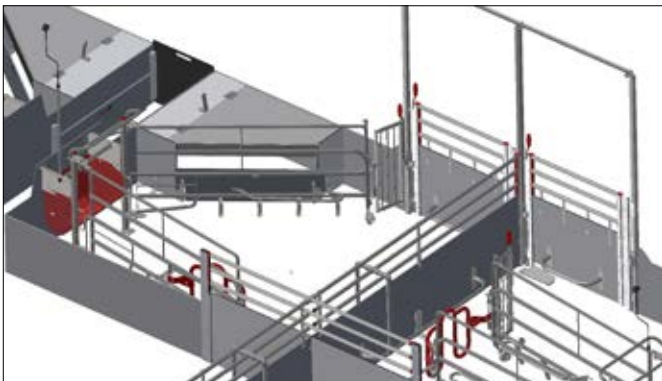
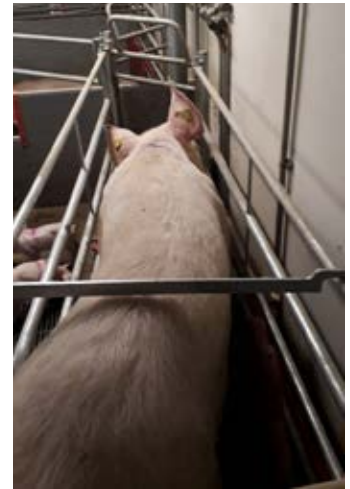

WELSAFE "MOVE" - front corridor

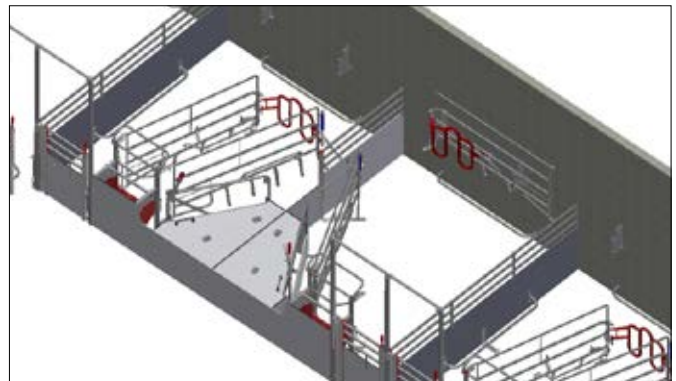

WELSAFE "MOVE" - front gate - movable wing

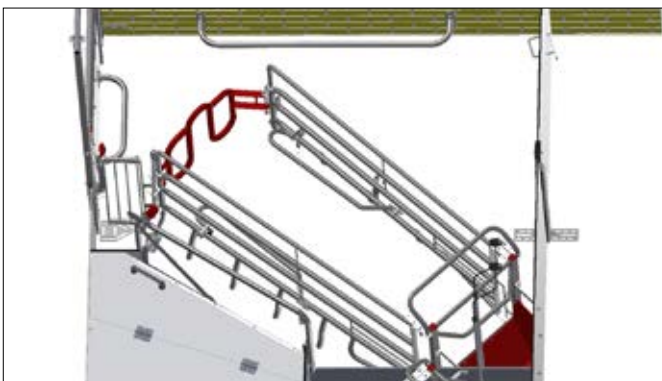

WELSAFE "MOVE" - regular piglet nest (0,75 m²)

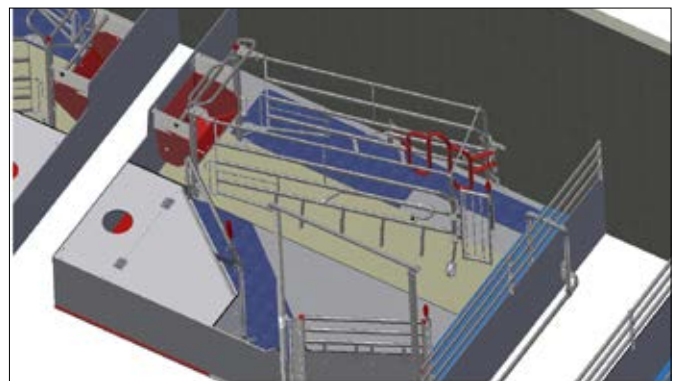

WELSAFE "MOVE" - XL piglet nest (1 m²)



FT-30 FARROWING PEN

Many years of experience for loose sows

FT-30 FARROWING PEN was designed based on the Norwegian preferences for loose nursing sows. The result is a very flexible pen that can be used from birth to piglets weight of approx. 30 kg. The pen contains a piglet nest with a lid designed in a fiber plate. The lid comes with or without hole for heating lamp



◀ FT-30 = FROM BIRTH TO 30 KG

By applying the “birth to 30 kg” system, you avoid transportation of piglets to the weaner unit. It means a lot less cleaning in comparison to traditional production. At the same time you save the pigs from stress, which gives a better daily gain and feed conversion.

FT-30 PEN		PIGLET NEST	
Pen length	300-340 cm	Width	110 cm
Pen width	240-260 cm	Area	1 m ²
U-profiles	2 mm stainless	Lid	with or without hole

▼ BOARD PROFILE OR FIBRE PLATE

FT-30 pen can be made of 35 mm PVC board profiles or 10 mm fibre plates.

DIMENSIONS	BOARD PROFILE	FIBRE PLATE
Side height	100 cm	96 cm
Rear part height	75 / 100 cm	61 / 75 / 96 cm
Gate height	100 cm	96 cm
SS bars height	100 cm	96 cm



INN-O-CRATE FARROWING PEN

Many weaned pigs, high weight at weaning

INN-O-CRATE is another model of the traditional farrowing pen. The farrowing box is adapted to the sow's anatomy and can be adapted to the sow's size. This means safe farrowing and "lay down/get up behaviour".



Testimonials:

“ We produce more than 40 weaned pigs pr. year sow in INN-O-CRATE farrowing crates.”

Martin Andersen, Risgaarden, Viborg, Denmark
2.150 sows, 83.000 weaned pigs



INN-O-CRATE is also available as side-facing model as well as with front exit. Contact us for more information.

▲ INN-O-CRATE FIBER FARROWING PEN

INN-O-CRATE is available with fiber partitions. It provides more space without compromising on quality. Fiber boards are very durable and impact resistant.

INN-O-CRATE FARROWING PEN

Traditional farrowing pen with multi-adjustable farrowing box

- Many weaned pigs
- High weight at weaning
- The farrowing box is adapted to the anatomy of the sow and can be adjusted to the size of the sow. This means safe farrowing and lying down/getting up behavior
- The design of the box side ensures that the piglets get unrestricted access to the nipple
- Tiltable wings minimize the risk of piglets crushing
- Smooth, easy to clean surfaces and rounded corners minimize the risk of dirt collecting
- Strong and well-proven construction that has taken the starting point in optimum overview and access for staff



FACTS

Pen length	2500 - 3000 mm
Pen width	1600 / 1650 / 1700 / 1750 / 1800 + variable 1600 - 2000 mm
Pen height	500 mm
Profiles	U-profiles 1,5 mm stainless
Board profiles	35 x 500 mm
Lying length	2000 - 2100 mm
Width farrowing crate, front	520 - 610 mm
Width farrowing crate, rear	580 - 850 mm
Height crate side	900 mm
Crate side	33,7 / 42,4 x 2,65 pipe
Volume trough	21 liter
Piglets nest width	800 / 900 mm
Piglets nest area	0,7 / 0,8 m ²

The rear gate's width can be set in 10 positions

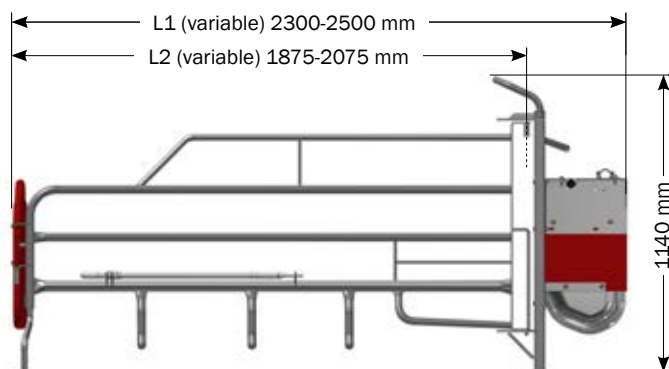
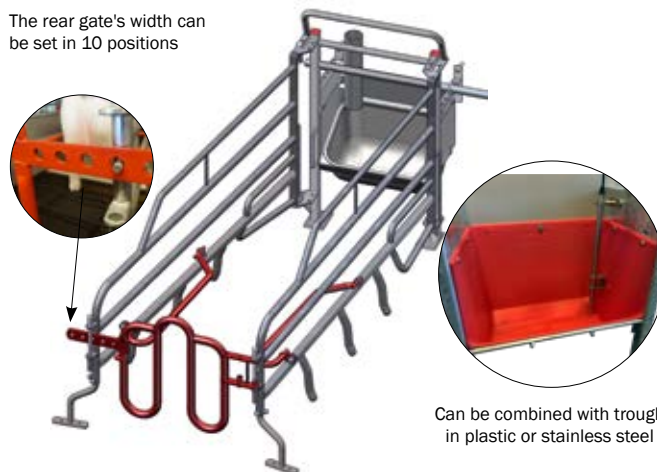

SETTINGS

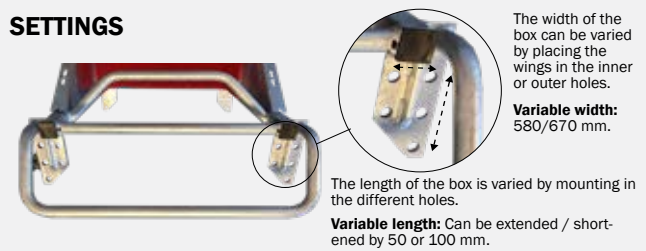

XL standard, with tiltable wings
L1 (incl.rear gate): 2400 mm } + 50 or
L2 (incl.rear gate): 1975 mm } 100 mm



XL short, with tiltable wings
L1 (incl.rear gate): 2300 mm } + 50 or
L2 (incl.rear gate): 1875 mm } 100 mm

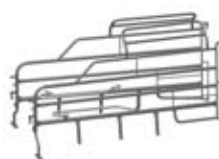

XL standard, with tiltable wings and upper structure, export
L1 (incl.rear gate): 2400 mm } + 50 or
L2 (incl.rear gate): 1975 mm } 100 mm



XL short, with tiltable wings and upper structure, export
L1 (incl.rear gate): 2300 mm } + 50 or
L2 (incl.rear gate): 1875 mm } 100 mm



FUNKI FARROWING PEN

Spacious sow crate - PVC or fiber

FUNKI FARROWING PEN F207 is our traditional farrowing pen. Sow crate with plenty of space for even the largest sows, both in the front and in the back.



▲ "SOFT" REAR GATE

The farrowing pen has one special detail - a soft rear gate. The rounded design takes care of the sows' rear part and provides plenty of room during the farrowing.



▲ FUNKI FIBER FARROWING PEN

FUNKI FIBER is made of fiber boards with the thickness of only 10 mm. It provides more space without compromising on quality. Fiber boards are very durable and impact resistant.

FUNKI FARROWING PEN

Traditional farrowing pen

- Sow cage with extra space for even the largest sows
- Maximum space for nursing piglets
- Large piglet nest: there is plenty of room for all piglets
- Simple and effective adjustment of the sow box
- Plastcoated soft rear gate - gentle to sows
- Tilt function of the rear part for greater safety during farrowing
- Extra large piglet nest for larger litters
- Delivered as side pens
- Strong construction with 50 x 50 mm posts



FACTS

Pen length	2500 / 3000 mm
Pen width	1600 / 1650 / 1700 / 1750 / 1800 + variable 1600 - 2000 mm
Pen height	500/750 mm
Profiles	U-profiles 1,5 mm stainless / H-profiles
Board profiles	35 x 250/750 mm
Width, front	560 mm
Width, rear gate	520-700 mm
Height crate side	1100 mm
Crate side	33,7 x 2,69 pipe
Volume trough	21 liter
Piglets nest width	800/900 mm
Piglets nest area	0,9 / 1,0 m ²

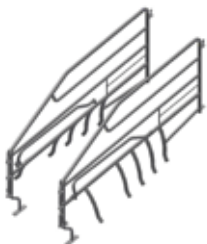
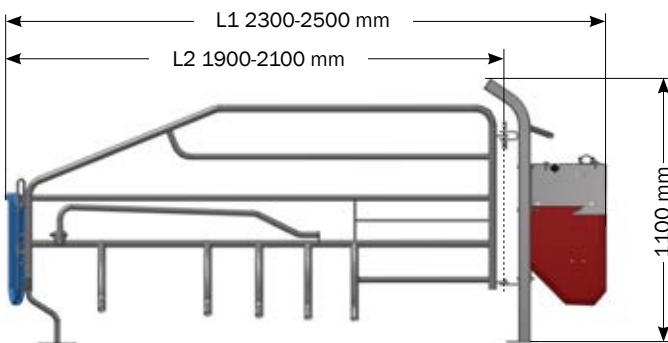
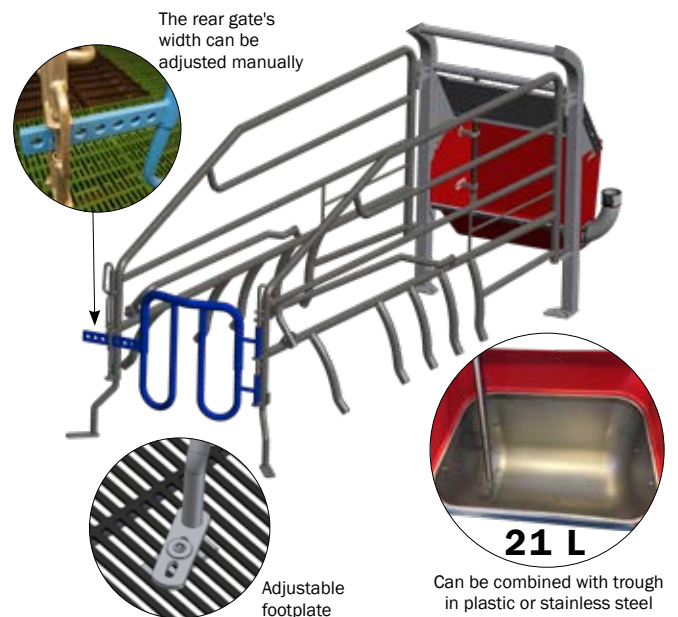

Farrowing partition F207 with tiltable wing
L1 (incl. rear gate): 2500 mm
L2 (incl. rear gate): 2100 mm



Farrowing partition F200S with tiltable wing, short model
L1 (incl. rear gate): 2300 mm
L2 (incl. rear gate): 1900 mm



Farrowing partition F200S without tiltable wing, with upper structure
L1 (incl. rear gate): 2300 mm
L2 (incl. rear gate): 1900 mm



▲ TILTABLE REAR PART

During farrowing and the next couple of days, the rear part can be tilted to cover openings in the slats, so that piglets do not get stuck.

SOW TROUGHS AND FEED BOWLS FOR FARROWING PENS

In stainless steel or plastic



UNIQUE SOW TROUGH

The design and mounting of the sow trough makes it possible to have a limited or no casting so that the sow can utilize the space below.

◀ "SAFE TILT TROUGH"

The farrowing box is available with tiltable trough, making it very easy, safe and ergonomic to clear the trough using a handle.



▶ FRONT EXIT

Option for front exit. In addition, with tilt function.

FEED BOWLS FOR PIGLETS AND WEANERS

FEED BOWLS FOR PIGLETS AND WEANERS		
Article no.	Description	Volume
90012	Mini feeder in plastic incl. fittings	1 liter
90013	Mini feeder in plastic incl. nut/bolt	1 liter
90144	Suspension bracket for mini feeder	-
96061	Feed bowl in plastic for piglets. Ø260 mm.	1,5 liter
96063	Feed bowl in plastic for piglets and weaners. Ø390 mm	4,5 liter
560395	Feed bowl Ø24 SS with hook	2,5 liter
06906	Round bowl FTK 27 with cone and inner rim	
03186	Feed bowl FT 19, H:80 mm, Ø190 mm	
554154	Feed bowl 326-T, H:60 mm, Ø260 mm	

- Easy to mount: round feed bowls are mounted with a spring loaded holder on the cast iron slat. Feeding pan for hanging are mounted with screw/bracket.

- Everlasting materials: plastic and stainless steel

- Hygienic: easy to reach corners - easy to clean



UNIFEEDER - INTELLIGENT FEED DISTRIBUTION IN THE FARROWING PEN



UniFeeder is easy to operate – the feed curve is embedded as a fixed default in relation to the content of the pre-starter mix and compared to a litter size of 14 piglets.

At the operation panel the feed manager can move the feeding curve and days, if necessary, to fit a larger or smaller litter size, or increase or decrease the amount of feed.



- Far fewer pigs are moved around
- Fewer nursing sows
- Uniform pigs
- No need to inject piglets with iron
- 700 g to 1 kg more weight at weaning
- No needle damage
- Does not require much cleaning
- Better and stronger heat

PIGLET NEST FOR FARROWING PEN

For an optimal draft-free environment

▼ INN-O-CORNER PIGLET NEST

- Optimum climate (closed sides that prevents draft)
- Tight assemblings and close connection between lid and fixed part
- Up to 0,8 m² covered area
- Individual adjustment possible
- Easy access
- Light construction
- Piglet nest can be right- or left-handed
- Width: 80 and 90 cm



▼ CURTAINS FOR INN-O-CORNER



The curtains are designed for INN-O-CORNER piglet nest and provide even better conditions for the piglets. Placing the curtains on the edge of the piglet nest helps to increase the average temperature in the nest by 2 °C. At the same time, it helps to prevent draught, giving better conditions for the piglets.



Testimonials:

“ After mounting the curtains, the piglets are 0,5 kg heavier at weaning than before.”

Martin Andersen, Risgaarden,
Viborg, Denmark
2.150 sows, 83.000 weaners

▼ SPECIAL SOLUTION FOR FARROWING

"Moving Floor "



◀ MOVING FLOOR

The construction has been developed especially for farrowing sows. The main objective is to create the best safety for both sows and piglets by minimizing the risk of crushing during farrowing. The *Moving floor* is stable and durable, and designed to be combined with other floors from ACO FUNKI.



HEATING PLATES FOR FARROWING AND WEANER PENS

Heated with EL or water



HEATING PLATES

The heating plate is used in farrowing pens to ensure optimal comfort for piglets and better survival ability during the first few days.

The heating plate requires only minimum maintenance, but at the same time ensures optimum growth conditions for even the smallest piglets. The bottom is provided with insulated foil material, so that the heat rises upwards.

EL-HEATING PLATES				
Description	Width x length, mm	Effect, W	Voltage, V	Max amount of plates to connect
El-heating plate, polymer concrete	400 x 1200	130	230	16
	500 x 1200	180		12
	800 x 1200	270		8
	500 x 1400	180		12
El-heating plate, plastic, rightward	400 x 1200	80		27
El-heating plate, plastic, leftward				



Hot water control for plastic and polymer heating plates

Controls inlet and outlet water. Each controller can regulate the temperature in 4 independent circuits.

HOT WATER HEATING PLATES	
Description	Width x length, mm
Hot water heating plate in polymer concrete	400 x 1200
	500 x 1200
	600 x 1200
	800 x 1200
	500 x 1400
Hot water heating plate in plastic	400 x 1200
	500 x 1200

Connection

In ACO FUNKI's heating plate for water, there are molded high-pressure pipes in polymer concrete with clamp fittings, which makes the installation easy and cheap.

In this model it is possible to connect in series up to 5 units, where the temperature is regulated by one thermostat.



FIRST-CARE® RUBBER HEAT MAT

For use during farrowing - the best start for newborn piglets

THE BENEFITS OF FIRST-CARE HEAT MAT

- Prevents undercooling
- 0,2 more live pigs per litter
- Healthier pigs that recover faster after farrowing
- Mobile and easy - can be placed and removed again
- Non-slip surface
- Easy to clean and disinfect

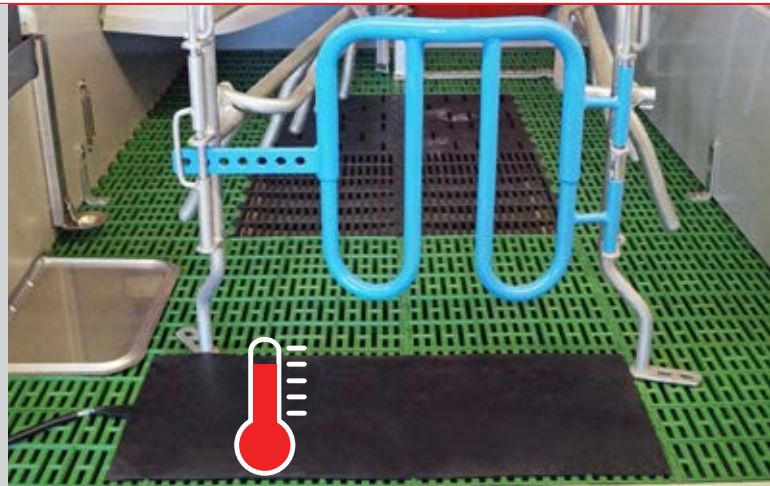

First-Care is a heat mat, which is placed behind a sow during the farrowing, so the piglets are born to a mat that is approx. 39°C warm. With the heat mat, the newborn piglets get more optimal life start, as the risk of undercooling is reduced. It is expected that the survival rate for newborn piglets will increase by 0,2 piglets per litter (based on the first statistical experience). After farrowing, remove the First Care mat.

Facts about First-Care heat mat:

- Electrical
- Connection: 220 V
- Dimension: approx. 350 x 850 x 8 mm
- Temperature: 39°C
- 3,5 m cable (with bite-resistant coating)



GREATER SURVIVAL CHANCES

Without the First-Care mat, the very first bedding for the newborn piglets is down to about 11°C. With the First-Care mat it is approx. 39°C; the piglets get a more gentle start to life, thus having greater survival chances.

▼ RUBBER MATS FOR PIGLET NEST

Alternatives to floor heating



- Alternative to floor heating
- Easy to maintain
- Comfortable climate
- Easy to mount on the slats
- Reversible "turtle" structure
- Sized that fit all our piglets nests

Article no.	Description
44112	Rubber mat for piglet nest 80 cm, reversible
44118	Rubber mat for piglet nest 90 cm, reversible
27000011	Insulating rubber mat 80 cm, left
27000012	Insulating rubber mat 80 cm, right
27000013	Insulating rubber mat 90 cm, left
27000014	Insulating rubber mat 90 cm, right



◀ RUBBER MATS PER RUNNING METER

The rubber mats are also available in whole rolls or per meter. Recommended for use in climate covers with FLEXCOVER. Can be adjusted in the longitudinal direction.

Article no.	Description
27000024	Rubber mat, width 1,2 m, length 30 m, price per roll
27000025	Rubber mat, width 1,2 m, price per meter

HEATING LAMPS FOR FARROWING PENS

Warm environment for piglets

HEATING LAMPS FOR COMFORT CORNER



▲ ADAPTER-RING

For all types of lamps

Description

- Heating lamp 21 cm 2,5 m cable, reg. plug
- Heating lamp 21 cm, 2,5 m CE-plug
- Lid for heating lamp
- Lock plate for heating lamp

"MASTER LAMP" HEATING LAMP

- The only heating lamp on the market that meets all requirements
- Splash proof (IPX4)
- Fine distance in dome shaped net < 50 mm
- Bayonet socket - easy to mount on the cover of the creep box
- Available with CE- and regular plug



50 cm

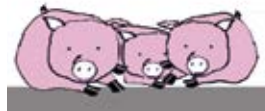

"MASTER HEATER" HEATING LAMP

- **Reduced energy**
Reducing energy consumption in the stables by up to 50% when combined with dual control.
- **Even distribution of heat**
Providing more equal distribution of heat than traditional heat lamps. This ensures better feed intake and a higher survival rate amongst piglets, as well as a reduction in use of medicine.
- **Waterproof IPX9K Approved**
Easy to clean and maintain. A high pressure cleaner is used for cleaning the Master Heater which means you don't have to disassemble the Master Heater. This helps in maintaining a high hygiene level.
- **Life expectancy**
As apposed to traditional heating lamps there is no use of incandescent bulbs for the Master Heater. 1 year warranty.
- **Low fire risk**
Master Heater obtains a lower temperature than traditional heating lamps, which reduces risk for fire.

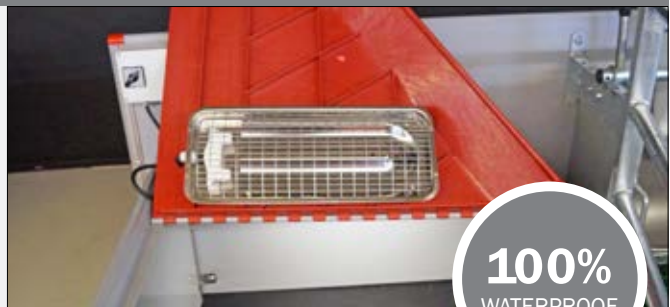

MASTER HEATER Incl. 240 cm cable

Description

- MASTER HEATER 100W without plug
- MASTER HEATER 150W without plug

Control

- Double contact for 2 MASTER HEATER
- Multi contact for 16 to 18 MASTER HEATER



UNICOMFORT & UNIHEATER

UniComfort is designed to control the environment in piglet nest with a UniHeater. The system keeps the temperature stable and optimal for the piglets in their critical start to life. UniComfort compensates for farrowing in day/night temperature as well as summer/winter influence on the barn temperature.

Uniform curve control of the microclimate in the piglet nest. The UniComfort controls the environment in 2 pens, each with its own sensor.

ACCESSORIES FOR FARROWING CRATE

Water supply for sows and piglets

WATER SUPPLY FOR SOW

Water supply	1" galvanized or stainless steel pipes
Water pipe for sow	23 mm SS pipe, stainless bracket and drill clamp
Nipple for sow	Stainless steel nipple, 1,3 liter per minute

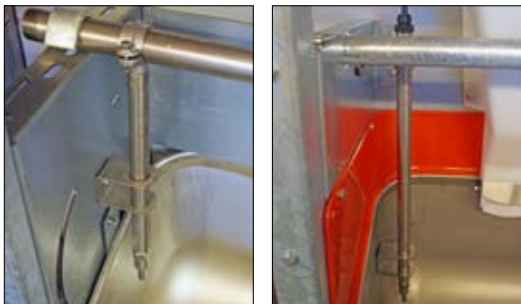

▲ STAINLESS / PVC WATER SUPPLY



▲ EB WATER - CLAMP FITTING



▲ DRINKING CUP FOR SOW AND PIGLETS



▲ SUCKLING/BITE VALVE (MANUAL)

WATER SUPPLY FOR PIGLETS



▲ VIP-O-MAT DRINKING CUP

- Cast solid and hygienic combination in strong and easy to clean plastic and stainless steel
- Top hygiene: the bottom plate can be tilted for emptying and cleaning
- Easy assembly
- Connected to sow water or separate



▲ DRINKING CUP FOR PIGLETS

- Stainless steel with height adjustable drinking valve
- No sharp edges = less accumulation of dirt and better hygiene
- Connect to water for sow



▲ DRINKING NIPPLE

- Casted solution in plastic with stainless bite valve
- Easy to mount, clean and maintain
- Complete with hoses and fittings for the water supply
- Connect to water for sow



▲ DRINKING CUP WITH STAINLESS PLATE

- Reduced water pressure; therefore very gentle for piglets
- Connect to separate water supply via reduction valve
- Stainless steel



BABY CARE

Automatic milk feeding system for piglets

BABY CARE is an automatic milk feeding system that distributes fresh milk in a farrowing unit all day. The system mixes the milk powder with hot water, and then adds cold water to get the right temperature. The system has an automatic milk demand control and can be set to mix small portions of milk.

BABY CARE ensures that all piglets have enough milk. When the piglets have constant access to milk, it results in a higher weight at weaning.

When the piglets are 1 kilo heavier at weaning, they have a faster growth after weaning and this gives a higher survival rate.



FACTS

Capacity	700 farrowing pens
Drinking cups	Max 50 per circuit
Milk temperature	Approx. 20°C
Milk powder consumption	130 g / 1 liter water
Adjustment of recipes	Touch screen



Testimonials:

“ With the Baby Care milk feeding system, we get more weaned piglets per sow. They are on average 1 kg heavier because they always have access to fresh milk.

In addition, we have reduced our medication consumption by 30%, and the pigs are generally very active and healthy. The system is 99% automatic.”

Nicolai Greffel
Isgård Gods Pig Production ApS, Denmark, 900 sows



REDUCE THE NUMBER OF NURSING SOWS

When the amount of piglets per litter is increased, it is important to ensure that all the piglets get access to enough milk in order to reduce the mortality.

Baby Care supplies extra milk, so the piglets can drink both the sow's milk and the milk powder.

It means you avoid having extra nursing sows, and thus reduce the amount of farrowing pens, your production costs and save man-hours.

BABY CARE PRINCIPLE

In the corridor between farrowing departments, there is one forward line and one return line.

There are manual valves to select either Water or Milk for the piglets. Besides, there are valves for circuit cleaning.

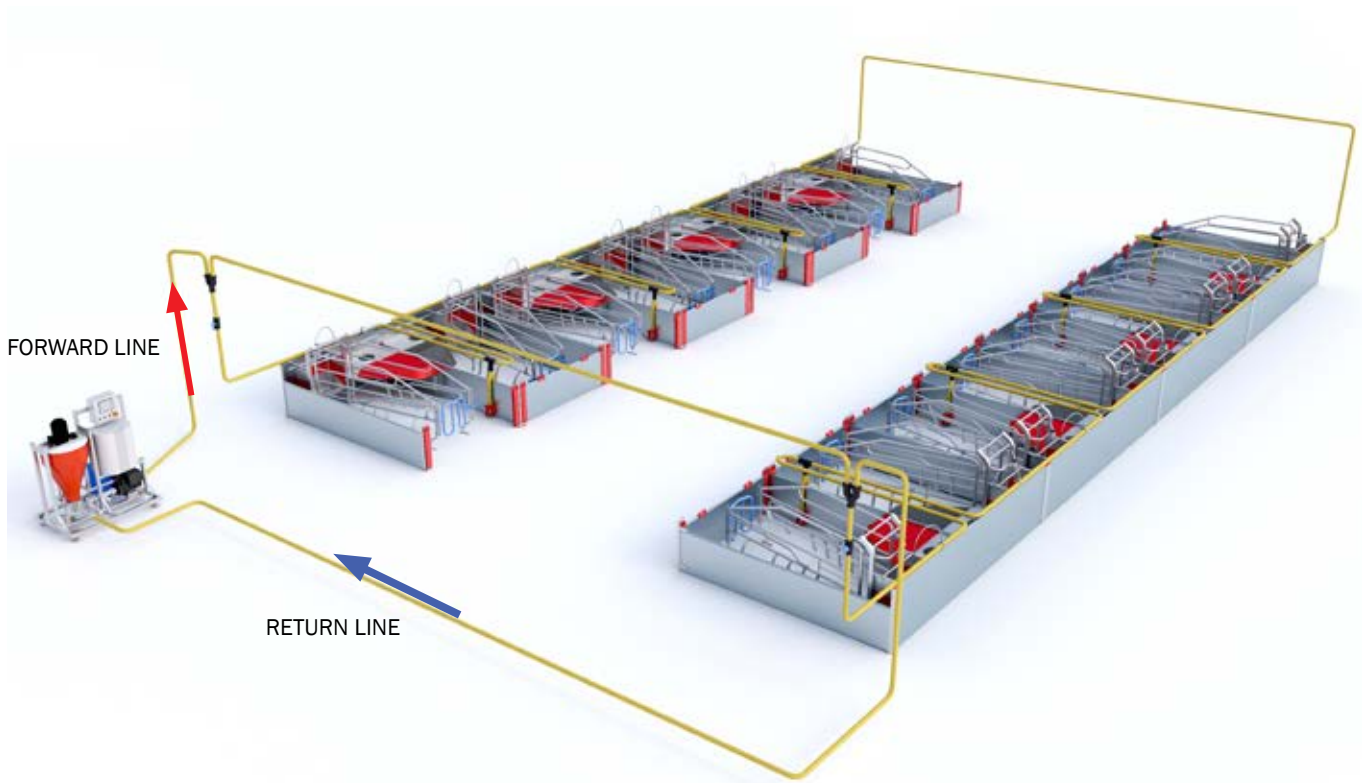
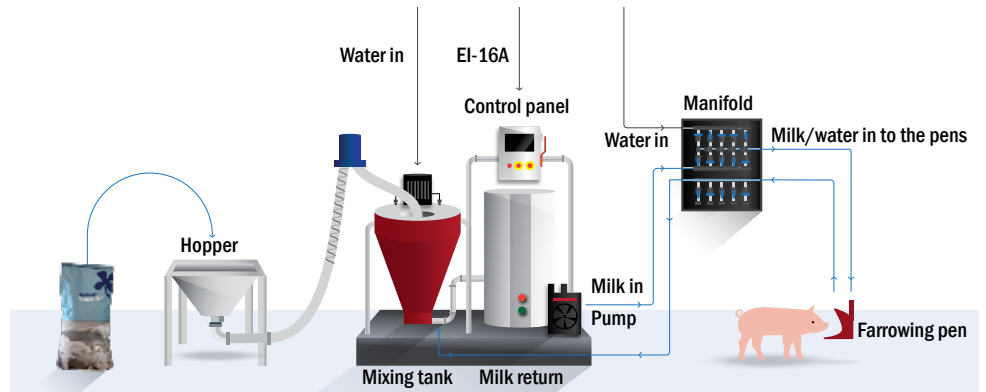

AUTOMATIC CLEANING PROCEDURE

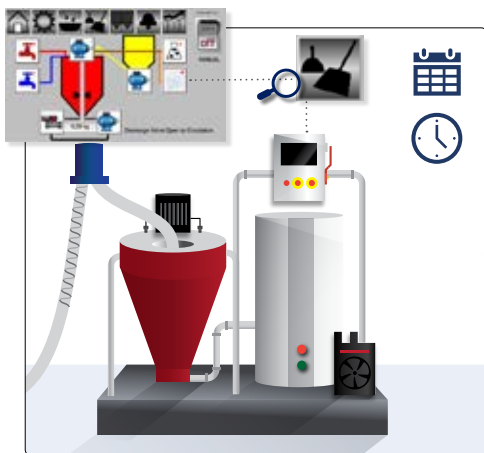

Choose the cleaning program on the touch screen.

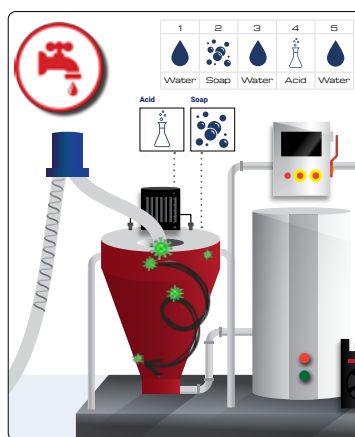

Add hot water, soap and acid.

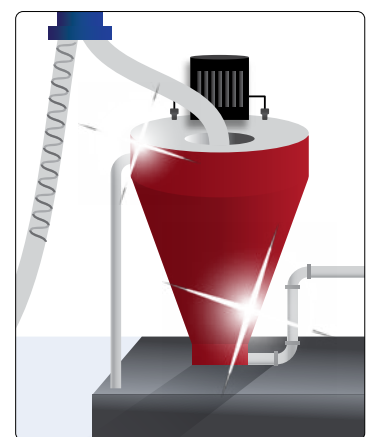

Start cleaning program. After finishing, the system is ready again.

WEANERS & FINISHERS

Countless options for weaners and finishers with quality fittings for CLEAN-O-FLEX, FUNKI FIBER and FUNKI FLEX from ACO FUNKI

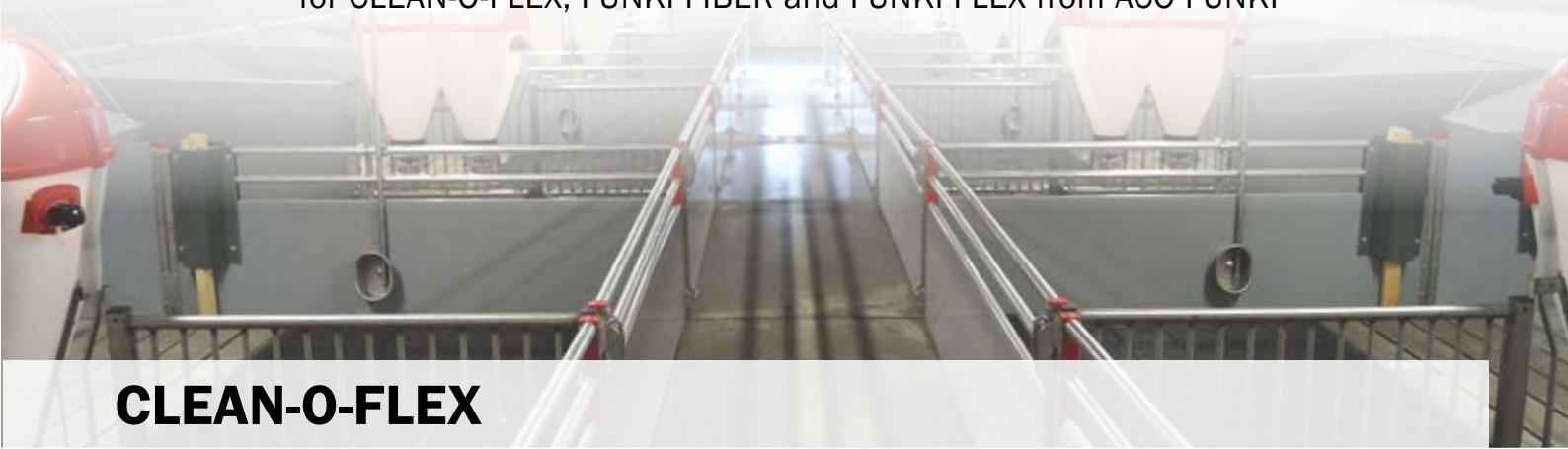

CLEAN-O-FLEX



FUNKI FIBER



FUNKI FLEX



FUNKI FIBER

Solid fibre plate reduces risk of infection

FUNKI FIBER is our penning equipment for weaners and finishers. The core in the equipment is a 10 mm massive compact panel, which, despite its thickness, is an extremely strong and durable material.

The entire construction is made of the compact panels without posts, and all the pipes end with the PVC adapters or plugs. It helps to reduce accumulating of manure in the difficult accessible places.

TYPE OVERVIEW	Height, mm		
	750	875	1000
Compact panel and 1 top pipe	x	-	-
Compact panel and 2 top pipe	-	x	-
Compact panel and 3 top pipe	-	-	x
Suspended gate	x	x	x
Gate in full width	x	x	x

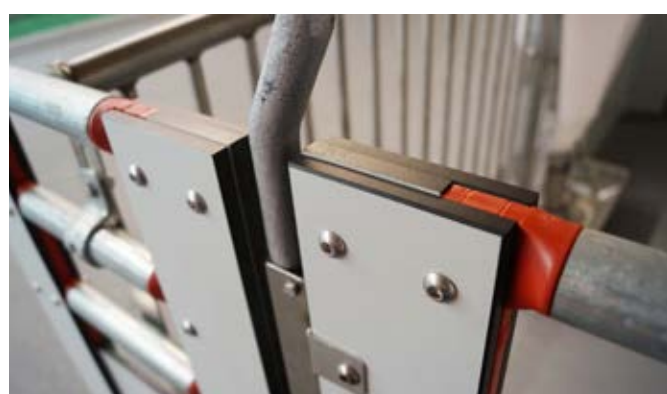

▲ DURABLE MATERIAL

FUNKI FIBER equipment is made of fiber panels that have a thickness of only 10 mm. It gives more space for pens without compromising on quality. Fiber panel is very strong and impact resistant material.

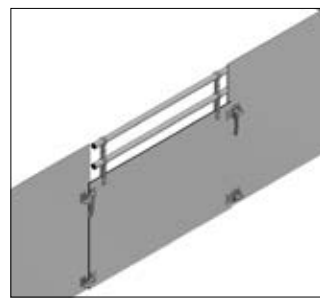

FUNKI FIBER with the gate in full width

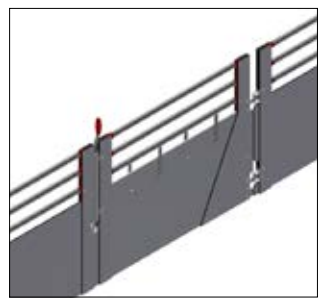

FUNKI FIBER with the regular suspended gate

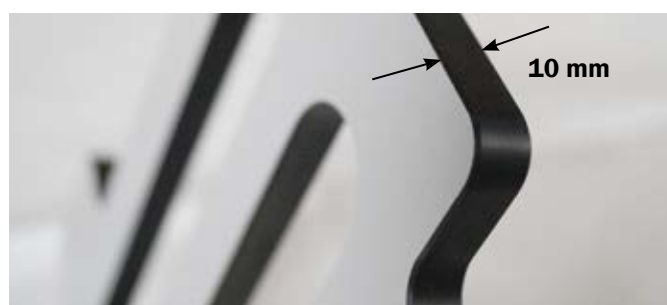

▲ GOOD HYGIENE

FUNKI FIBER equipment is made of fiber panels, where all edges are rounded to minimize the risk of injuries. The closed equipment contribute to a specially good hygiene and have bactericidal properties.





CLEAN-O-FLEX®

Well-sealed equipment

CLEAN-O-FLEX® is a flexible system based on stainless U-profiles. With standard height of 75 and 100 cm it can be used especially for weaners, WEAN-TO-FINISH and finishers.

▼ WEANERS

The height of the CLEAN-O-FLEX equipment for weaners is 75 cm. Delivered in assembled units up to 360 cm. For length above 280 cm, retaining bracket is required.

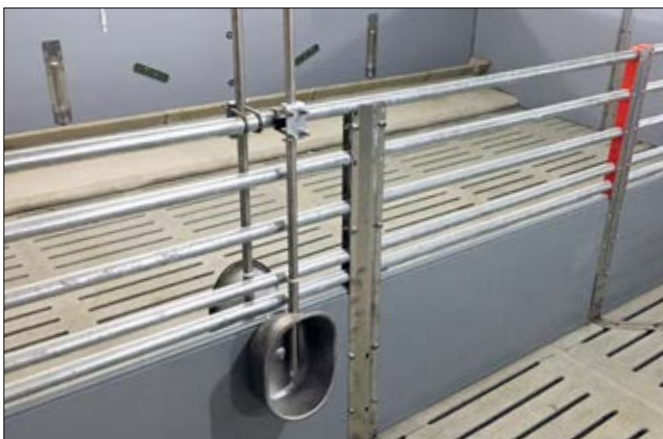
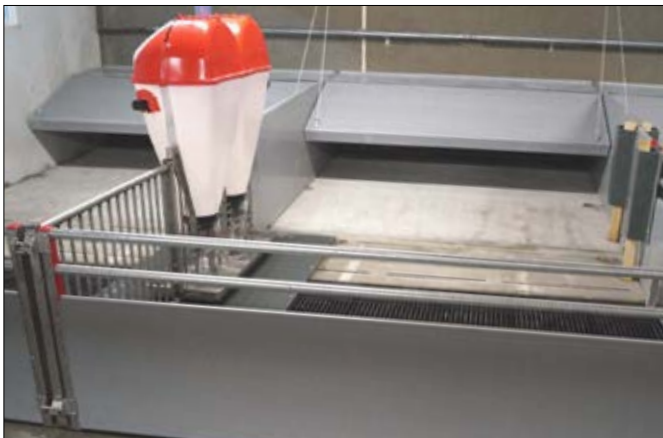

SUPERIOR PRODUCTIVITY

- Focus on finish: plastic plugs, rubber sealing and locking system ensure completely tight and closed equipment everywhere. It ensures the possibility for easy and effective cleaning and thus new stall effect whenever the pen is washed.
- Rounded edges and corners ensure animals welfare.

TYPE OVERVIEW - options

Height, mm	Pin lock	Twist lock	Full width gate	Qty of pipes	Closed
750	-	x	x	2	x
850	x	-	-	3 / 1	-
1000	x	x	x	5 / 2	x

U-PROFILES

1,5 mm stainless steel in patented design

PVC BOARD PROFILES

35 mm with patented zig-zag reinforcement

PIPES

33,7 x 2,65 mm hot galvanized



◀ FINISHERS AND WEAN-TO-FINISH

The height of CLEAN-O-FLEX® equipment for finishers and Wean-to-Finish is 100 cm. The equipment is delivered mounted up to 360 cm. For length above 250 cm, stiffening bracket is required.



FUNKI FLEX®

Penning equipment for weaners and finishers

FUNKI FLEX is our flexible penning system for weaners and finishers, and it is made of corrosion-free materials, PVC and stainless steel. The PVC board profiles are closed at the top and at the bottom. Strong foot plates in stainless steel or cast iron.



▲ STRONG CONSTRUCTION

FUNKI FLEX is made of 35 mm strong PVC that does not rust or break. Stainless steel screws ensure that the pigs do not get damaged. The FUNKI FLEX equipment has no sharp edges and has warm and animal-friendly surface. Quick drying and reheating after washing.

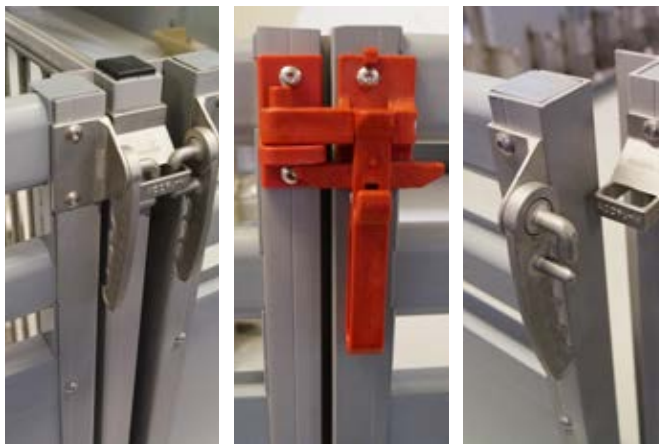

▲ STRONG HINGED GATE

The gate can be operated with one hand, which makes it easier to take single animals out of the pen. Closed towards aisle, which means no manure in the aisle.

FUNKI FLEX has a height of 75 cm for weaners, 85 and 100 cm for finishers.

TYPE OVERVIEW - variations

Height, mm	Pin lock	Full-width gate	Qty pipes	Closed
750	x	x	2	x
850	-	x	-	x
1000	x	x	1	x

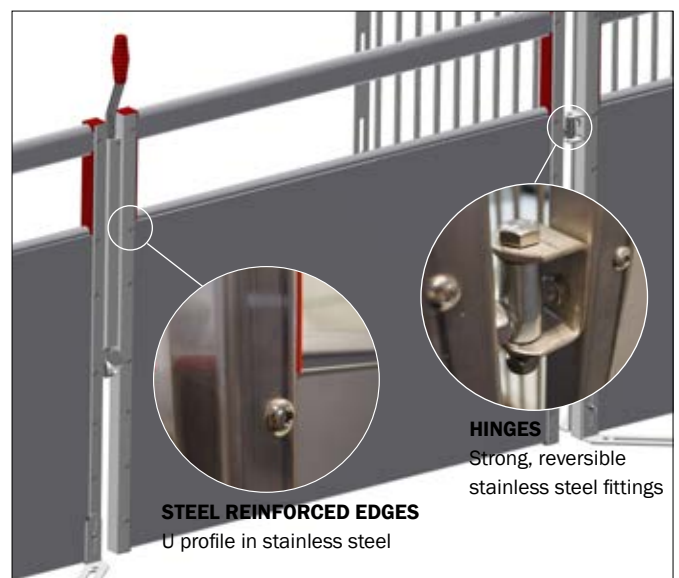

STEEL REINFORCED EDGES

U profile in stainless steel

HINGES

Strong, reversible stainless steel fittings

The gate operated by one hand, which makes it easy to take some animals out of the pen. It is closed towards aisle, preventing manure residues in this area.

FUNKI FLEX UNASSEMBLED

FUNKI FLEX equipment can be delivered unassembled. It is easy to mount, as many details are connected with a "click" system. Flexible equipment with many options.



PORK TUNER

Precise and individual feeding for specific body weights and performance levels

Automated delivery

The PorkTuner is a smart system that weighs each pig and directs it to one of two feeding areas with the diet best suited to the pig's weight. Diets can be determined based on daily growth data.

Continuous data collection on growth allows accurate forecasting of weight development, allowing for planning deliveries and transport up to 4 weeks ahead. When a pig reaches market weight, the PorkTuner automatically cuts it from the group by directing it to a delivery section.

Unlimited farm size

PorkSense is scalable and perfectly suited for multi-site production systems. The management of all these pigs is performed at a central location with the PorkSense dashboard.

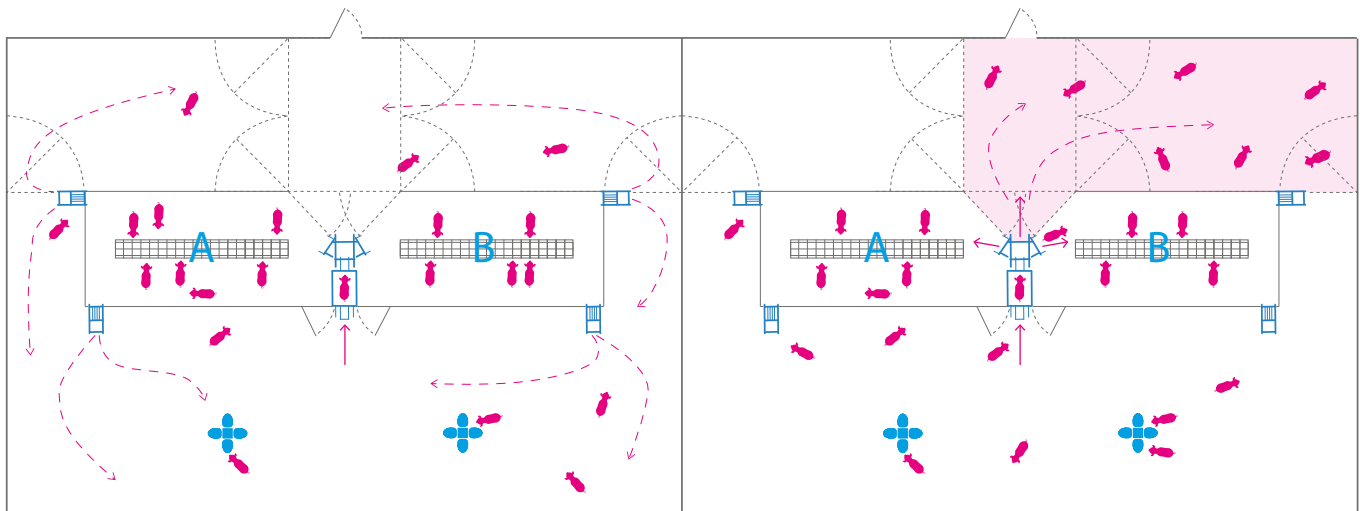

99% floor-space utilization
 Weight registration & Sorting
 ← Feed-A 50%:50% Feed-B →

Delivery phase



- More opportunities to meet the requirements for manipulating material for the pigs
- Solutions for weaners, finishers and sows
- Minimizes the risk of, for example, tail biting and other inappropriate behavior
- Supports the pigs' natural behavior

RUMMAGING MATERIALS

Meet pigs needs to investigation behaviour

Pigs investigate their surroundings by performing digging, sniffing, biting and chewing movements. Therefore, a lack of investigation and manipulation materials can adversely affect the behavior of the pigs. Some weaners and finishers develop tail biting behavior that is related to their current motivational state.

Therefore, the current Danish legislation set up the minimum standards for the protection of pigs. According to the current rules, "pigs must have permanent access to a sufficient amount of materials that they can properly investigate and manipulate."

We offer several types of manipulation materials adapted to different types of pigs and pens.

► STRAW RACK in fibre material

For farrowing pens



▼ HOLDER FOR RUMMAGING MATERIALS

1: For weaners and finishers

2: For farrowing pens



STRAW RACK ► IN GALVANIZED STEEL

1: For weaners and finishers

2: For sows





- Plastic with rounded profiles all over and thereby no sharp edges
- Light, but at the same time durable construction with 15 mm plastic board profiles
- Tight fittings ensure top hygiene and easy cleaning; developed for modern pig production
- Designed for modern pig production; can withstand frequent washing
- Hinge rails with flexible rubber hinge ensures draft-free environment
- Many combinations and built-in options

FLEXCOVER® climate cover

All advantages in one product

FLEXCOVER climate covers

FLEXCOVER is a climate cover for weaner units, that consists of the fixed part and the openable part. FLEXCOVER has many built-in options with 25, 50 and 75 cm board profiles in combination with flexible hinge rails. The climate cover is made of 15 mm PVC board profiles and is available in different variations as 2-parts, 3-parts or sloped.

FLEXCOVER - overview			
Depth, mm*	Type	2-parts, mm	3-parts, mm
850	Straight	250/500	-
1100	Straight	500/500 + 250/750	-
1160	Straight	-	250/500/250
1350	Straight	500/750	-
1600	Straight	750/750	-
1100	Sloped	250/750	-
1350	Sloped	500/750	-

* Max width is 300 cm. If the width is more than 300 cm, an extra post is required.



▼ OPEN/CLOSE-FUNCTIONS

FLEXCOVER can be opened and closed by means of whether electrical motor or hand winch.



El-motor for central lifting



Hand winch, complete 500 kg

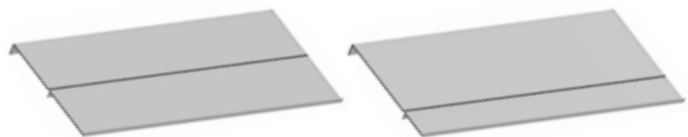

2-parts 500 / 500 mm

2-parts 250 / 750 mm

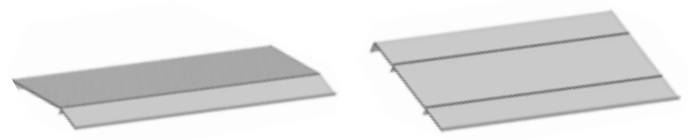

2-parts, sloped 250 / 750 mm

3-parts 250 / 500 / 250 mm

PVC BOARD PROFILES, PROFILES, FITTINGS AND PLUGS

CLEAN-O-FLEX® and INN-O-PLUG

- **Pressure and twist stable**
Zig-zag lamellas give a high degree of stability compared to regular panel division
- **Durable**
Pure, new lead free PVC (differences in color can occur)
- **Tight joints**
Rubber strip is glued to the upper edge of the panels
- **Simple and fast mounting**
Rational click system
- **Easy to clean**
Tight, strong and smooth surface and rounded bottom

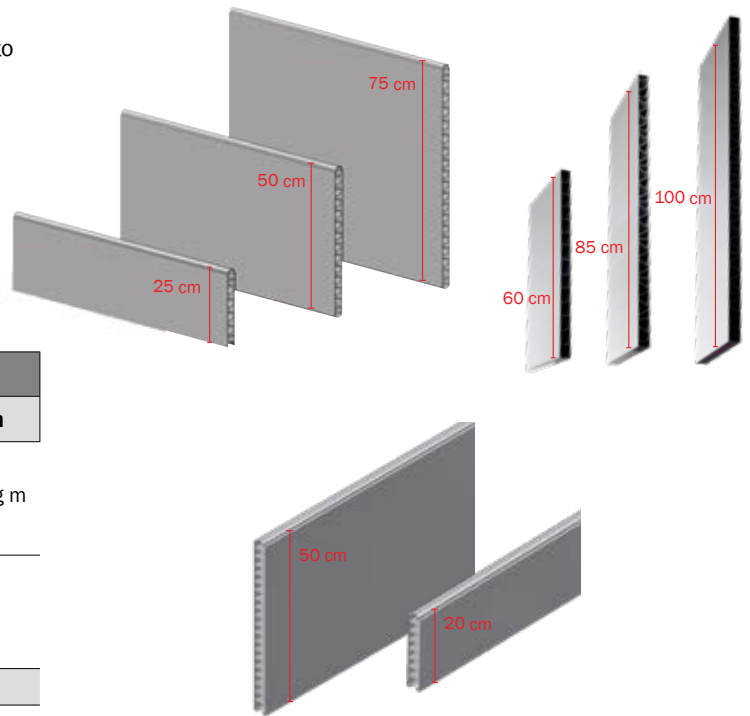

TYPE OVERVIEW	Dimensions	
Description	Height x Width, mm	Length, m
CLEAN-O-FLEX PVC board profiles 35 mm, fer/not	35 x 250	6 m / running m
	35 x 500	
	35 x 750	
CLEAN-O-FLEX PVC board profiles 35 mm, flat-flat	35 x 600	Up to 8 m
	35 x 850	
	35 x 1000	
40 mm. Extra strong. For sows, gilts and boars		
PVC board profiles 40 mm, fer/not	40 x 200	6 m / running m
	40 x 500	

PROF LINE STEEL PROFILES & PVC LINE PROFILES

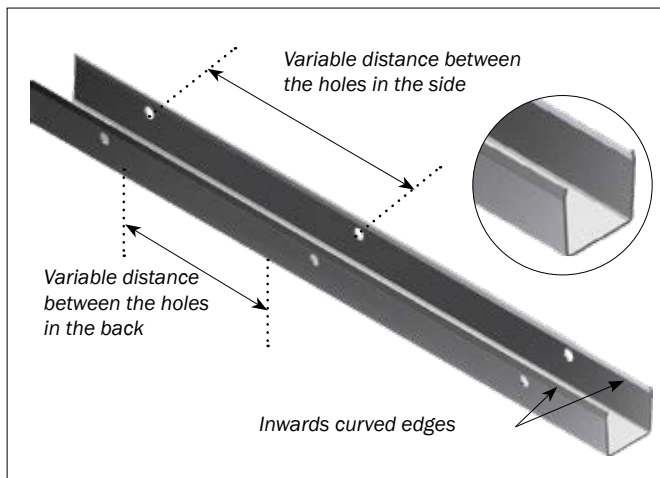

* U-profiles are available in tailor-made length. Distance between the holes as well as the holes' shape can be adjusted to your needs.

Contact us for more information.

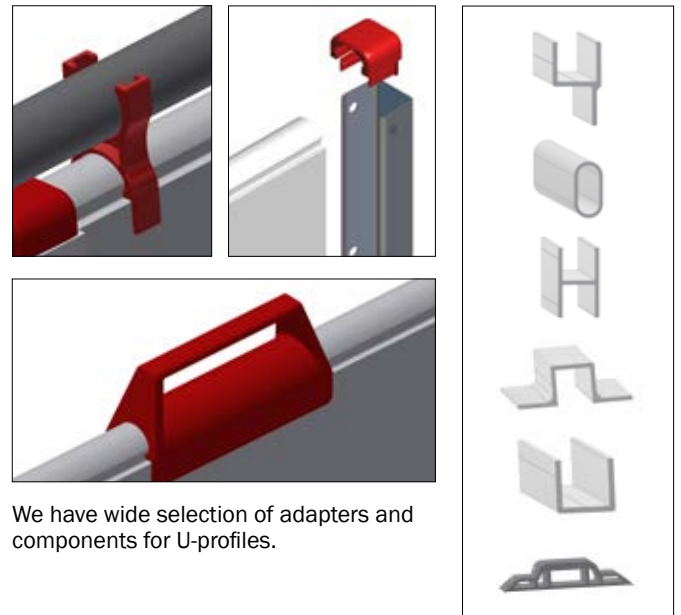

We have wide selection of adapters and components for U-profiles.

INN-O-PLUG

INN-O-PLUG is a system for fixation of foot brackets, slats and concrete slats and for mounting of equipment parts.

- **Everlasting**
Stainless steel
- **Low damage risk**
Rounded screw and bolt heads
- **Easy to mount**
Designed for use of torx-tools - more sturdiness
- **Do not get loose**
Due to coating the bolts stay tightened

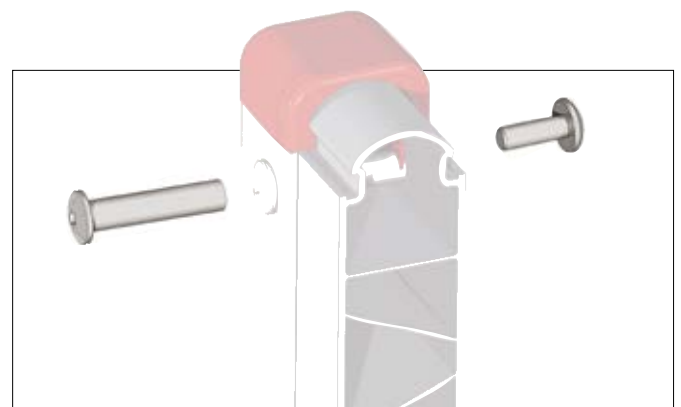

FLOORING

Our floor program for farrowing pens, weaners and finishers give you innumerable combinations and solutions

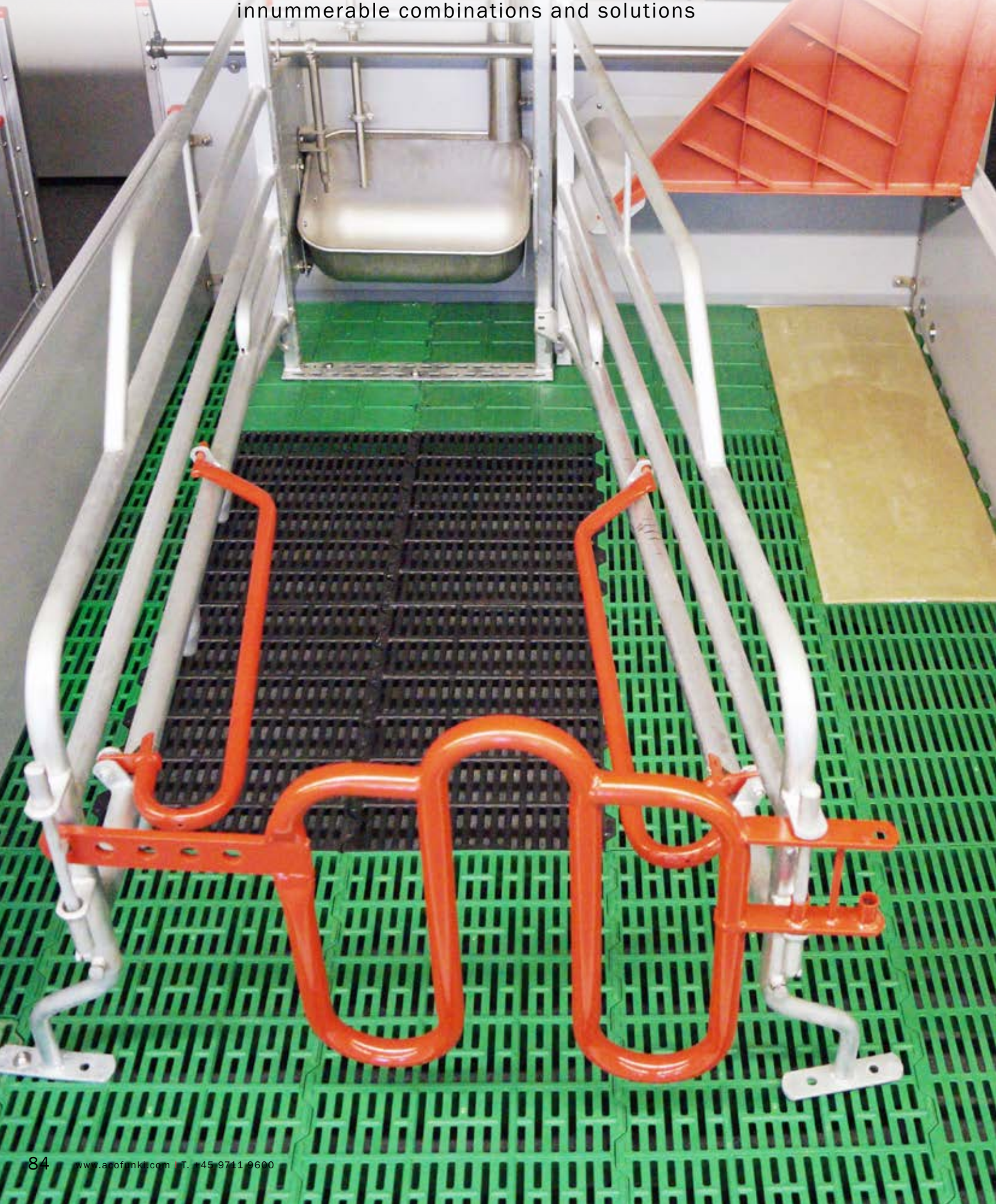

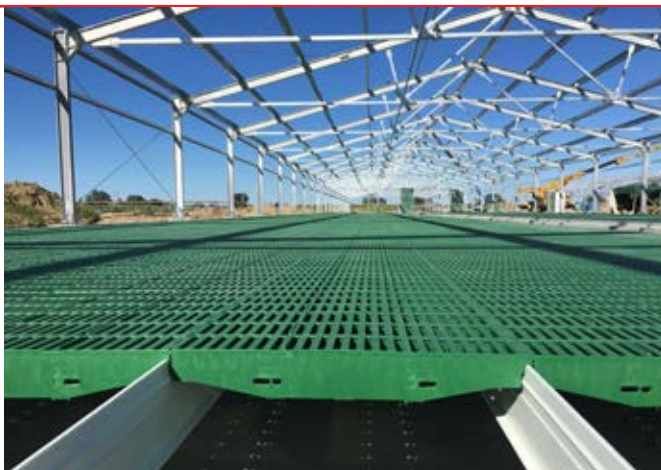

Combine according to your needs

- Flexibility and maximum hygiene in farrowing unit
- Fully drained floor
- 100% new PP-plast or cast iron

Easy to clean

- Manure passage and easy cleaning

Comfortable for both sow and piglets

- Plastic is warm and hygienic for the piglets
- Can be combined for ex. with unique drain plate made of cast iron under the sows shoulders to prevent compression damage



PLASTIC SLATS FOR SOWS

ACO FUNKI sow slats are made of durable polypropylene material. The slats' surface structure is specially adapted to the animals anatomy, and it ensures very good slip resistance and, at the same time, high comfort.

PLASTIC SLATS FOR WEANERS

Plastic slats for weaners with 10% opening

The special plastic slate has an innovative surface structure and 10% opening. It helps the piglets stay warm and dry. In addition, it excludes the risk of their claws to be caught in the holes.

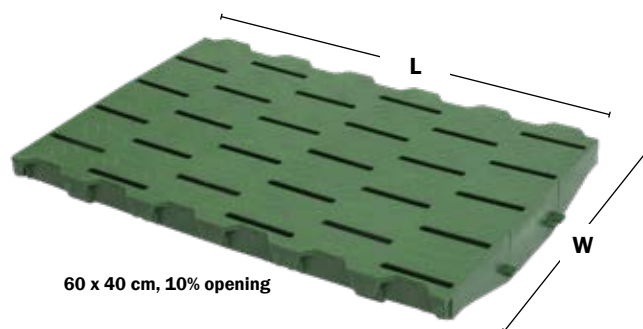

60 x 40 cm, 10% opening

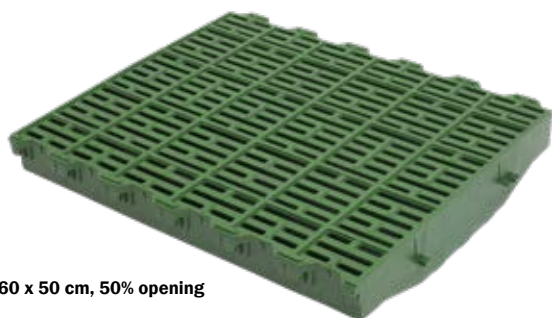

60 x 50 cm, 50% opening



60 x 40 cm, closed

Testimonials:

“ New piglet farm was built in 2016, identical sections, the only difference is the floor. The small details make the big difference: 6 hours washing time for ACO FUNKI floor vs. 7,5 hours washing time for not ACO FUNKI floor. It means 20% more washing time for the not ACO FUNKI floor. ACO FUNKI floor is also more stable and strong.

Karsten Kur Jensen, Risgaarden, Viborg, Denmark
2150 sows, 83000 weaners

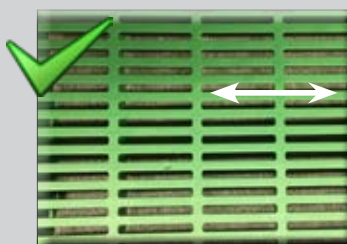

ACO FUNKI FLOOR:
Washing time: 6 hours per section

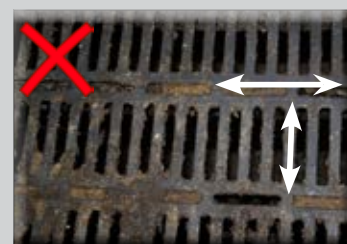

NOT ACO FUNKI FLOOR:
Washing time: 7,5 hours per section

COMBI-FLOOR

Plastic and cast iron slats for COMBI-FLOOR

TYPE OVERVIEW - plastic slats for Combi-floor						
Description	Article no.	Length, cm	Width, cm	Closed	10%	50%
Plastic slats for sows	565060	60	50			x
	09102	60	40			x
	18054	10	40			x
	17383	60	40	x		
	18094	30	20			x
	17328	30	30			x
	18721	30	60			x
Plastic slats for weaners	17384	60	50			x
	09100	60	40			x
	18604	60	40		x	
	566160	60	60	x		
	566260	60	60		x	
	566360	60	60			x

TYPE OVERVIEW - cast iron slats for Combi-floor								
Description	Article no.	Length, cm	Width, cm	Closed	5%	50%	STEP	Plug
Cast iron slats for farrowing pens	566060	60	60			x		
	566063	60	60			x		x
	564060	40	60			x		
	563060	30	60			x		x
	561060	10	60			x		
	566040	60	40			x		
	566041	60	40		x			
	566042	60	60		x			
	564063	40	60	x				
	564061	40	60			x	x	
	564062	40	60	x			x	
	566080	60	80			x		
	566085	60	80			x		

60 x 40 cm, 50% opening
60 x 80 cm, 50% opening

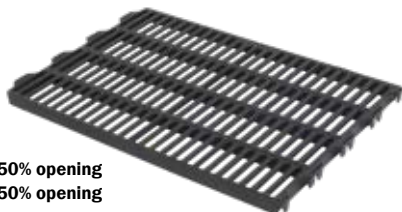

60 x 40 cm, 5% opening
60 x 80 cm, 5% opening



60 x 40 cm, STEP, closed



▼ STEP-SYSTEM

The STEP-system is especially designed to elevate the sow's lying area in order to reduce the risk of crushing the small piglets by the sow, thus, reducing piglets' mortality. Furthermore, customers' experience shows, that piglets have better conditions for nursing.

Testimonials:

“ Increased productivity from 33,60 piglets per sow/year to 36,80 piglets per sow/year from January to August 2016.

This increase in productivity was reached after rebuilding their farrowing pens with ACO FUNKI's STEP-system. The farm has got several awards in Portugal for productivity.”

"Exploração Nuno Correia - Ota" farm, Portugal



COMBI-FLOOR FOR FARROWING PENS

Support and accessories



ACCESSORIES FOR COMBI-FLOOR

We have of course all the accessories necessary for mounting and support of COMBI-floor - from fiber glass supports to anchors and fittings.

Contact us for a complete overview and price-list.

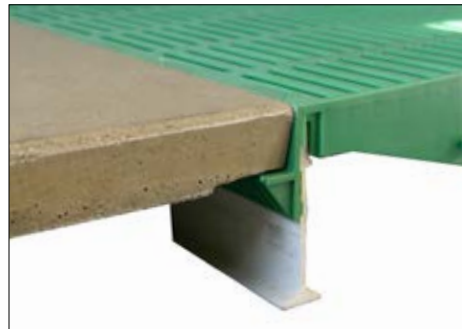
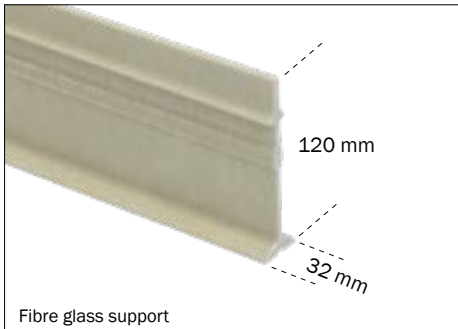

◀ STRONG FIBER GLASS SUPPORT Suitable for long farrowing pens

- Unique fiber glass profile
- Resistant to twisting
- High carrying capacity

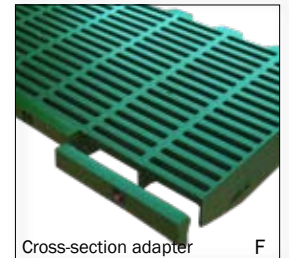
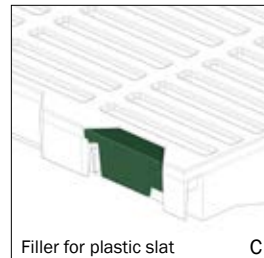
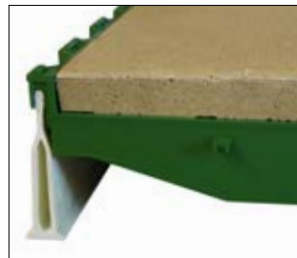
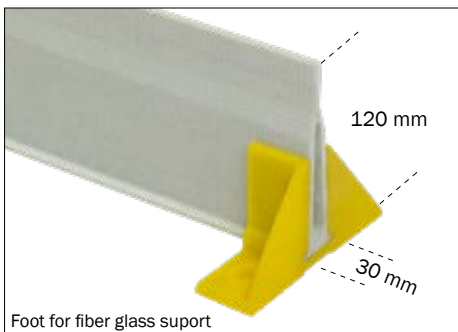

▲ DELTA SUPPORT

SUPPORT					
Description	Size (mm)	Max span length (cm)		Length (cm)	
Galvanized support for farrowing pens	50 x 5	<160			
	60 x 5	160-200			
	80 x 5	200-280			
	100 x 5	280-320			
	120 x 5	320-350			
		Weaners	Sows	w/cast iron under sow	
Fiber glass support for farrowing pens	70 x 32	160	120	-	600/spec. length
	120 x 32	280	240	260	500/550/600/spec. length
Fiber support for farrowing pens	70 x 32	-	-	-	590/spec. length
	120 x 32	-	-	-	590/spec. length
Delta-support	120 x 30	310	270	280	285/900/spec. length

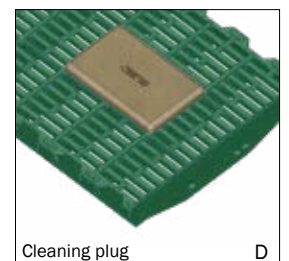
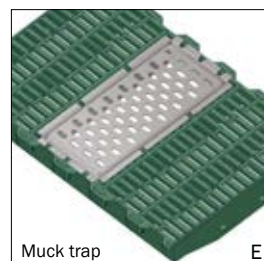
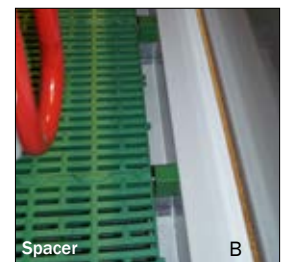
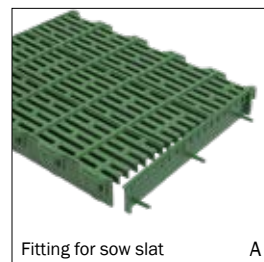

ACCESSORIES

Article no.	Description	
17666	Fitting for slat 40 cm green	A
17667	Fitting for sow slat 40 cm green	-
8500301	Spacer for PVC floor 30 x 40 x 58,3 mm	B
09105	Filler for plastic slats	C
554164	Cleaning plug, polymer, f/plastic slat L21 x W13 x H7 cm	D
01777	Cleaning plug L13 x W10 x H15 cm	-
18169	Muck trap for farrowing pens, stainless steel, 38,5 x 18,5 cm	E
18083	Cross-section adapter for plastic slat, 20 cm	F

▲ ACCESSORIES FOR PLASTIC SLATS

- Good design
- Innovative solution
- Lower mounting costs
- Easy adjustment in length and width

SELF-SUPPORTING CAST IRON SLATS

Flexibility and hygiene

HEALTH CONDITIONS IN FOCUS

- Slightly rough surface makes the slat slip-resistant
- T-shaped ribs ensures optimum manure passage

MINIMUM WORKING TIME CONSUMPTION

- Large cleaning opening
- Hard surface and minimum surface area

ENVIRONMENT AND ECONOMY

- Long lifetime - good for both environment and economy
- Same bearing surface and height as triangle slats, that can easily be replaced
- Self-supporting = low mounting costs
- Small surface = low emission



TYPE OVERVIEW	
FARROWING PENS	Dimensions, mm
Beam: 10 mm Slot: 11 mm	800 x 400 x 30
	900 x 400 x 30
	1000 x 400 x 30
	1100 x 400 x 30
	1200 x 400 x 30
	1400 x 400 x 30
WEANERS AND WEAN-TO-FINISH	1600 x 400 x 30
	1200 x 400 x 30
	1400 x 400 x 30
	1600 x 400 x 30
	1800 x 400 x 30
FINISHERS	2000 x 400 x 30
	1600 x 400 x 30
	Beam: 30 mm Slot: 15 mm Cleaning opening: 40 mm

ACCESSORIES

We have several types of covers and fittings for cast iron slats. Contact us for a complete overview and price list.



Our cast iron slats are specially designed to fit the cover rib. Easy mounting by means of allen wrench.

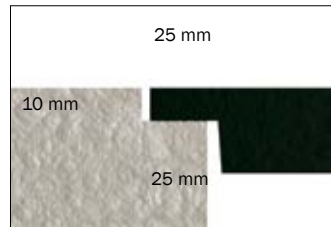

Cast iron slats have the same bearing surface and height as for ex. triangle slats, that can easily be replaced.



ACCESSORIES FOR FLOOR MOUNTING

Fittings

FOR PLASTIC SLATS	
Article no.	Description
30847	Anchor M8 plastic slats
90130847	Anchor M8 for plastic slats, big
30888	8 x 90 machine bolt (Torx 50)
30887	8 x 120 machine bolt (Torx 50)
30308071	Buttonhead stainless M8x70 w/o washer
1900515	Anchor 8 mm, 30x35x9 mm, w/o screw, 10 pcs.
17095	Slat anchor 8 mm, green (10 pcs.)
17128	Slat anchor 10 mm, green (10 pcs.)
18958	Slat anchor romb, weaner slat (10 pcs.)

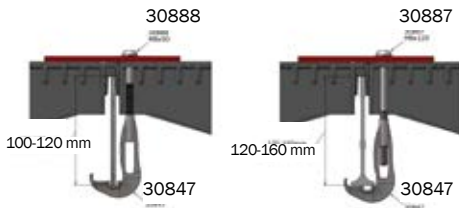

FOR CAST IRON SLATS	
Article no.	Description
1900241	Bolt-on fitting, 10 pcs
96967	Bracket for mounting, 10 pcs.
4800008	Bolt-on fitting with 2 threads, 10 pcs.

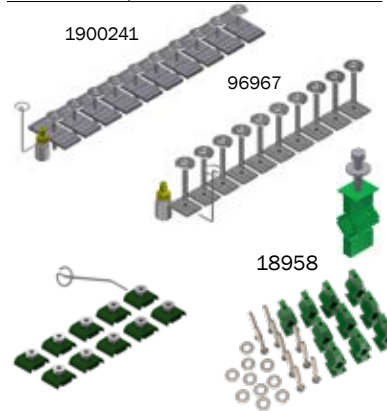

FOR CONCRETE / WALL	
Article no.	Description
39406050	Concrete screw 6,5 x 50 Torx 27
67442	Coach screw 10x100 mm Torx 50
67444	Coach screw 10x70 mm Torx 50
39900001	Wall plug 12x60



FOR CONCRETE SLATS	
Article no.	Description
30871	T-anchor 80-100 mm
30875	T-anchor 100-120 mm
30872	Buttonhead M10x90 Torx 50
90100079	50 mm displaced T-bolt
30310080	Buttonhead M10x80 Torx 50
90100078	T-bolt cast M10 SS
30878	Retaining tool for mounting

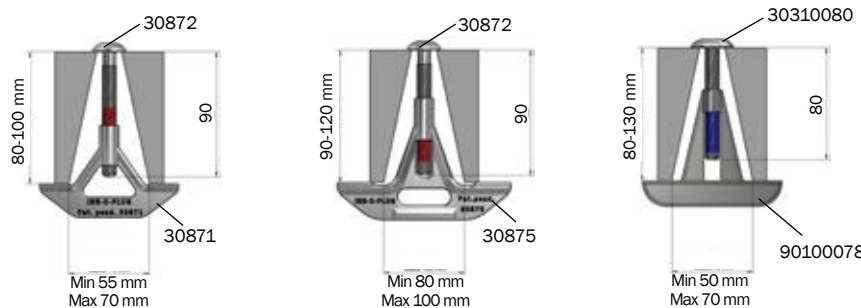

Tested to a pull of 1,9 Tons
Tightened with 80 Nm

Tested to a pull of 1,8 Tons
Tightened with 50 Nm

Tested to a pull of 2,3 Tons
Tightened with 100 Nm



INN-O-PLUG for slatted floor	
Article no.	Description
30873	INN-O-PLUG set, slat anchor 80-100 mm incl. screw
30882	INN-O-PLUG set, slat anchor 100-120 mm incl. screw
480020	T-bolt for concrete slats, 10 pcs.
96967	Fitting for mounting of equipment on cast iron slats, 10 pcs.

INN-O-PLUG for PVC board profiles	
Article no.	Description
39106020	6 x 18 screw internal torx, stainless
39206037	8 x 37 inset pipe nut, stainless
4900466	Connecting screw set 39-48 mm, stainless
4900467	Connecting screw set 44-58 mm, stainless
4900468	Connecting screw set 49-68 mm, stainless

INN-O-PLUG for plastic slats	
Article no.	Description
30847	Anchor, SS, for mounting of plastic slats on support iron
30888	8 x 90 machine bolt (torx 50) for fibre glass support
30887	8 x 120 machine bolt (torx 50) for fibre glass support
30308071	Buttonhead M8x70 without washer TORX 50
30130487	Anchor M8, large

RETAINING TOOL	
Article no.	Description
30878	Retaining tool for mounting of slat anchors



WATER SUPPLY

Complete water supply

WATER FILTER SYSTEM



SECTION PIPE SYSTEM

32, 50, 63 mm



MAIN WATER SUPPLY
50, 63, 90 mm

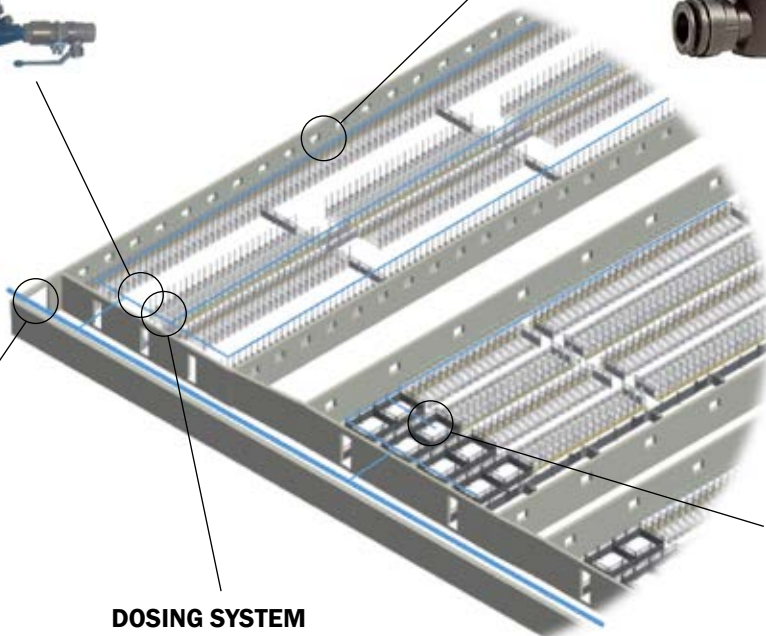

FLEXIBLE CONNECTION SYSTEM
For hoses and pipes



DOSING SYSTEM



RELIABLE WATER SUPPLY

MASTER FLOW is a membrane-operated valve system, which maintains a constant water level in the trough.

The MASTER FLOW water level valve has two entrances with ½" internal threads for horizontal and vertical water pipes.

The water level valve is delivered with a plug in order to be able to close the entry not used.



For optimum use we recommend the following:

- Water supply with a prefilter
- Water pressure of 2,0 - 2,5 Bar/29 - 36 PSI
- The supply pipe - the vertical water pipe from the water level valve to the trough must be at least 80-200 cm
- The supply pipe should be placed as far from the feed outlet as possible
- Regular cleaning of the supply pipe in order to avoid water contamination

WATER LEVEL VALVE

Article no.	Description	No. on picture
93469	MASTER FLOW incl. ½" plug	1
06902114	Water pipe ½", stainless steel, 1195 mm with 1 thread	2
06902115	Water pipe ½", stainless steel, 1495 cm with 1 thread	-
42220	Sow trough in stainless steel	3
96054	Stainless bracket for trough fastening. Incl. 4 stainless bolts for fastening to bracket and bolts for fastening on wall.	4
Spare parts		
93467	Membrane for MASTER FLOW	-
93465	Control button for MASTER FLOW	-

▼ TILT TROUGH

Plastic or stainless steel

◀ TILT TROUGH FOR SOWS

15-20 pigs pr. trough



▼ TILT TROUGH FOR WEANERS

25-40 pigs pr. trough



SPRINKLING AND SOAKING

Dosing system - Additive system

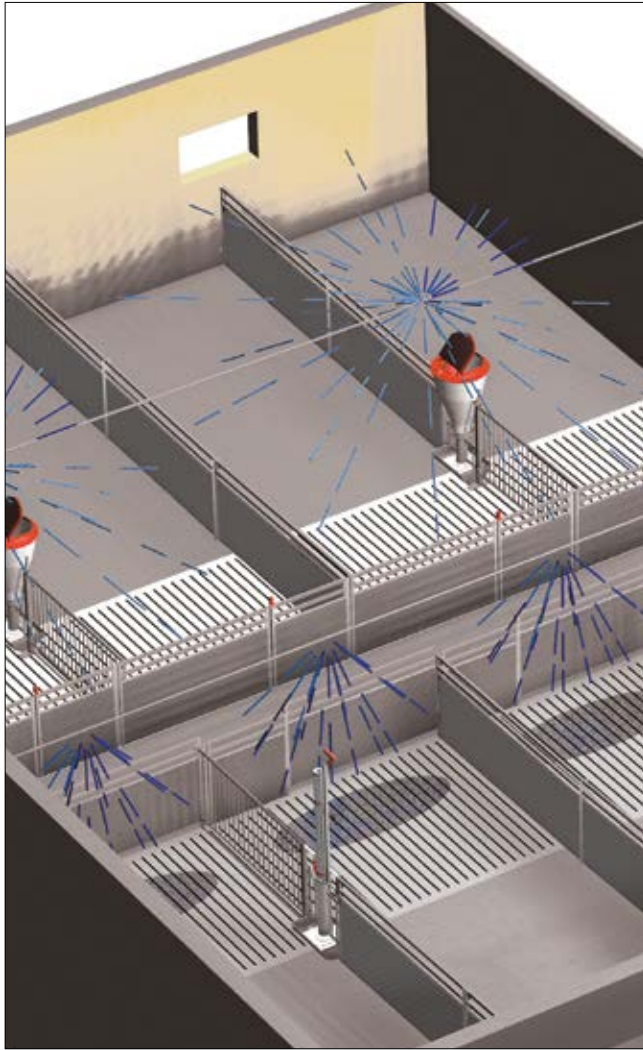

WATER FILTER

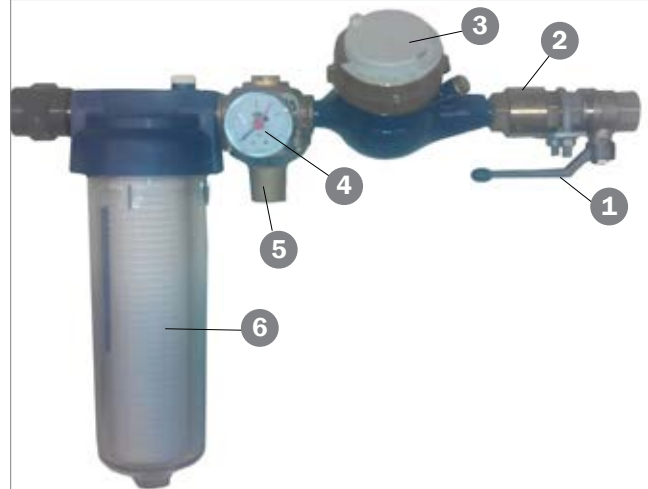

WATER FILTER

No.	Description
1	Valve 3/4" with handle
2	Check valve 3/4"
3	Water meter 420 QN 1,5 DN15=1/2- 3/4 KLB 165 mm. 40 gr.
4	Pressure gauge 1/4"
5	Reducing valve 11BIS 3/4"
6	Water filter 3/4" sleeve
-	Filter 50 MY
-	Coupling 1/2 X 3/4
-	3/4" brass nipple pipe
-	Water filter set

DOSING SYSTEM



DOSING SYSTEM

No.	Description
1	Tee PVC 90° 32 mm TN16
2	Angle PVC 90° 32 mm TN16
-	Thread socket PVC 3/4" 32 mm int.
3	Ball valve PVC Ø32 mm, 1 X union
4	Pipe PVC w/glue socket 32 mm rm
-	Medicine mixer 0,2-2,0% inlet
-	Medicine mixer set

ADDITIVE SYSTEM

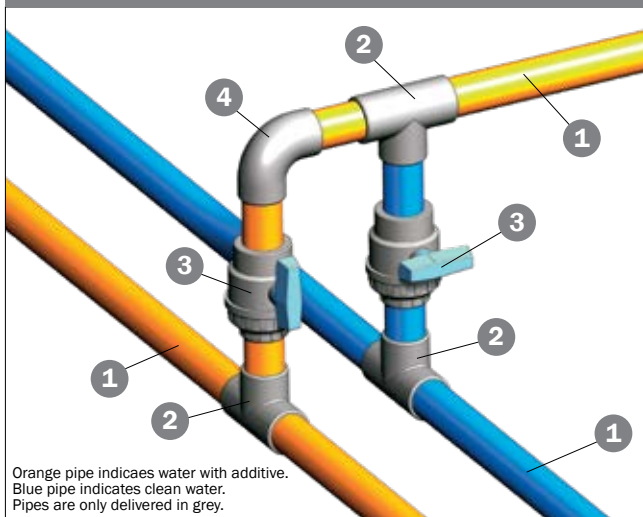

ADDITIVE SYSTEM

No.	Description
1	Pipe PVC w/glue socket 32 mm r.m
2	T-piece PVC 90° 32 mm TN16
3	Ball valve, glue, 32 mm x 1 union
4	Angle PVC 90° 32 mm TN16

DRIK-O-MAT® DRINKING CUP

The original drinking cup

- Hygienic design
- Robust and durable
- Good water savings due to minimum water wastage
- Made of stainless steel
- Available in different sizes and designs that are specially adapted for weaners, finishers, sows and wean-to-finish
- Up to 30 pigs per drinking cup



SPECIFICATIONS			
Description	For	Pigs per cup	Mounting height
MINI	Weaners	30	12 cm
STANDARD	Finishers	30	25 cm
MULTI	Wean-to-Finish and sows	30 weaners	12 cm
		20 finishers	12 cm
		10 sows	35 cm
MAXI	Sows	10	35 cm

DRIK-O-MAT®

The heaviest thickness of material in the market and closed, bend edges guarantee a very strong drinking cup, which lasts for years. The bend edges also prevent dirt accumulation and injuries.

The rounded design ensures that there will be no blind corners and the closed design above prevents dung in the drinking cup and thereby it will always be clean. The water nipple is placed in the bottom of the drinking cup and releases only the amount of water that is actually drunk. This means considerable water savings and considerable reduction in the quantity of slurry.



DRIK-O-MAT® is delivered with a 23x2 mm water pipe with internal thread and bracket as well as with 1/2" adjustable drinking nipple in stainless steel.

▼ WATER VALVES

For drinking cups and feeders



PRESSURE, BITE AND TILT VALVES

We can supply a wide range of water valves that meet the functional requirements for sows, finishers, weaners and piglets.

- Available with different threads to fit pipes of several sizes.
- The valves have different capacities to meet the requirements for water volumes
- We have of course the valves that fit our drinkers and feeders

The valves are designed for pressure of 2.5 bar.

PRESSURE VALVES				
Article no.	Description	Adjustable	L/min (at 2,5 bar)	Thread
281490	Pressure valve 3in1 SS	yes	4	1/2" int.
12100342	Pressure valve 3in1 SS type11	yes	4	1/2" int.
93305	Pressure valve SS	yes	4,5	1/2" int.

TILT VALVES				
Article no.	Description	Adjustable	L/min (at 2,5 bar)	Thread
93250	Tilt valve for DRIK-O-MAT	yes	4	1/2" ext.
560153	304 SS valve for drinking cup	yes	7	1/2" ext.
281496	Tilt valve for TUBE-O-MAT pipe	yes	4	1/2" ext.
93245	Tilt valve for TUBE-O-MAT	no	4	3/8" int.
9900047	Tilt valve SS type 17	no	7	1/2" int.
93280	Tilt valve sows 13	no	4	1/2" ext.
12100107	Drinking valve 1/2 SS type 13	yes	5	1/2" int.

BITE VALVES - STAINLESS				
Article no.	Description	Adjustable	L/min (at 2,5 bar)	Thread
9900053	Bite valve SS, weaners	yes	2,5	1/2" ext.
9900054	Bite valve SS, finishers	yes	4	1/2" ext.
93345	Bite valve SS, piglets	yes	1,5	3/8" ext.
9900058	Bite valve sows, brass	yes	6,5	1/2" ext.
93343	Bite valve sows, stainless	no	3	1/2" ext.



GALVANIZED SILO

Environmentally friendly silo of recyclable material

Excellent feed flow

- Obstruction-free hopper plates with smooth protective internal coating.

Wide range of capacities and features

- Four different diameters with volumes from 3.9 m³ to 49.8 m³
- Unique range of day bins from 0.5 m³ to 2.5 m³
- Bins for pneumatic or mechanical filling

Options available

- Safety platform
- Solid construction. It complies with the German DIN standard (DIN18194)

Keeps feed fresh and nutritious

- Heavy galvanization and corrugated sheets reduce temperature fluctuations inside the bin

Durable and maintenance friendly

- Encapsulated external bolts to prevent corrosion
- 5 year warranty against perforation by corrosion!
- Environmentally friendly – material can be recycled after use



▲ FILLING SYSTEM

mechanical, pneumatic or mechanical/pneumatical



▲ BIN WEIGHING



▲ PLASTIFIED BOLTS



FIBRE GLASS SILO

Silo with good ability for thermal insulation



◀ Suitable for cold climates

The fiberglass silos of ACO FUNKI are synonymous with lightness combined with high resistance to environmental extremes, high tenacity and great thermal insulation.

Fiberglass silos are very durable, they do not rust and they do not require special maintenance. Moreover, they can be supplied as one-piece (monolithic) silos or as horizontally or vertically split silos. All of them grant an easy check of the product level through a transparent strip located in the body.

Model	Legs	Volume		DIMENSIONS					
		m ³	Ton	A	B	C	D	E	F
AF04	3	4,0	2,4	3720	1050	250	1600	2500	1530
AF06	3	6,0	3,6	4190	1050	300	2000	2500	1870
AF08	3	8,0	4,8	4780	1050	300	2000	2500	1870
AF10	3	10,0	6,0	5080	1050	300	2200	2800	2045
AF12	3	12,0	7,2	5620	1050	300	2200	2800	2045
AF15	4	15,0	9,0	5980	1050	300	2400	3000	2230
AF18	4	18,0	10,8	6650	1050	300	2400	3000	1815
AF20	4	20,0	12,0	6900	1050	300	2470	3000	1885
AF26	4	26,0	15,0	7620	1050	400	2600	3000	1975
AF31	4	31,0	18,6	8800	1050	400	2600	3000	1970
AF40	4	40,0	24,0	8450	1050	500	3000	3500	2260
AF52	4	52,0	31,2	10010	1050	500	3000	3500	2260
AF66	4	66,0	39,6	12010	1050	600	3000	3500	2260

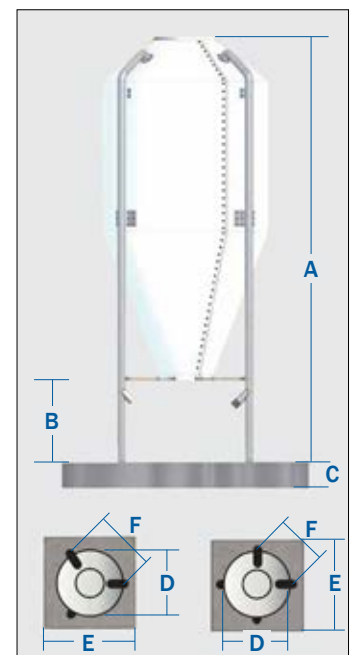

BIOSECURITY

Protect your farm from ASF and other infections

BIOSECURITY is the implementation of measures that reduce the risk of disease outbreaks. Protection against the serious, infectious diseases is crucial to prevent outbreaks of disease that can have severe financial consequences.

We have classified the biosecurity measures in six groups: AIR, WATER, FEED, TECHNOLOGY, DESIGN, HUMAN FACTOR.

We have developed the practical guidelines for each measure and can give you specific advices depending on your needs. Contact us for more information.



▼ CLEAN BOX

Disinfection of equipment and tools

CLEAN BOX is a box with UV lamps that can disinfect 95% of the items. It is particularly suitable for avoiding the risk of infection applied via dirty items used in the pig barn.

The CLEAN BOX is built in stainless steel with two doors. In the box is a stainless-steel grate on which the item to be disinfected is placed on. There are 4 UVC lamps in the box to ensure disinfection of the items, as well as the air in the box.

The doors can only be opened individually, ensuring that no contamination from one area to another can occur.



DISINFECTION OF:*

Coli i luft, Legionella	5 sec.
Eberthella typhosa, Measles virus	15 sec.
S. enteritidis, Staphylococcus albus, Poliovirus, Influenza, Corynebacterium diptheriae	20 sec.
Bacillus anthracis, Neisseria catarrhalis	25 sec.
Infectus Hepatitis, Bacillus subtilis	30 sec.

*99% disinfection of all light-accessible surfaces. The starting point is an item placed in the middle of the box.

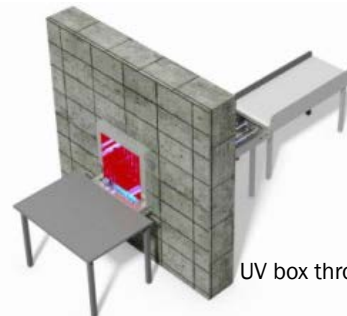

UV box through the wall



DESIGN

GENETICS

FEEDING &
GRAIN
STORAGE

FINANCES

HOUSING
TECHNOLOGY

SLURRY
SYSTEM

EDUCATION &
MANAGEMENT

GREEN
ENVIRONMENT

**VISIT US AND
LEARN MORE!**



DANISH PIG ACADEMY

Complete farm solutions



ACO FUNKI is a member of Danish Pig Academy - a collaboration of independent Danish companies within equipment and services for pig production. The Danish Pig Academy is a gathering point for both international and Danish pig producers as well as other interested persons, groups, institutions and organizations within the pig industry.

At Danish Pig Academy, you will meet the leading Danish companies, excelling within the field of modern pig farming. The Danish Pig Academy has established the unique showroom in Denmark full of professional equipment and inspirational environment. We have everything you need for your professional pig farm. All at one place!

40 PIGLETS PER SOW PER YEAR

Get inspiration and build the most profitable pig farm

We offer you the best of Danish technologies, so that you can achieve the best results.

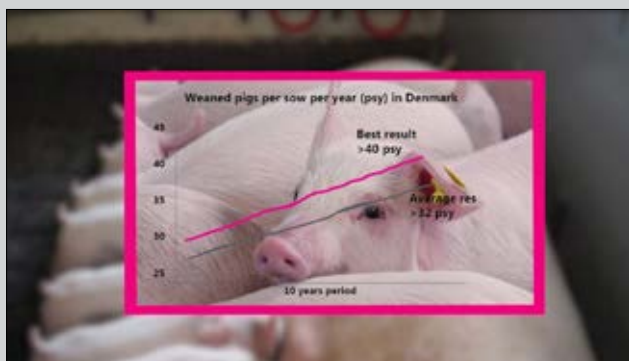

Production results for the top-leading Danish farms



www.danishpigacademy.com

biosecurity – breeding – conveyor systems – courses and training – dry feeding farm management – feed heating
insemination – IT solutions liquid feeding – nutrition and supplements – penning – silos
slats & flooring – slurry system – farm design – buildings – ventilation – wash robots

VISIT US

GET INSPIRATION IN OUR SHOWROOM

We have a great two-levels showroom located in Herning, Denmark. Here you can see different kinds of penning equipment for modern pig farming as well as our best solutions for dry and liquid feeding, drinking and flooring systems, components and much more.

Without any commitment you can see, feel and try out the differences and thereby choose the solution that matches exactly your needs.



CONTACT US

You are always welcome to contact us if you would like to visit us or have further questions:

Tel.: +45 97 11 96 00

E-mail: acofunki@acofunki.dk



ACO WORLD

STRONG CORPORATE SUPPORT



ACO FUNKI is a part of ACO Group, a world market leader in drainage technology. With its integrated approach, ACO stands for professional drainage, efficient cleaning, and the controlled discharge or reuse of water. ACO Group is built on intense research and development, and its technical expertise in processing polymer concrete, plastic, cast iron, stainless steel and reinforced concrete.

ACO is present in over 50 countries, with a total of 40 production sites in 20 countries. With a global workforce of 5,300, the company generated sales of Euro 1,15 billion in 2022.



As part of ACO Group, we have the opportunity to manufacture our products at ACO's own production facilities located in 20 countries, often even close to the end user in order to offer the most competitive price.



As part of ACO Group, we have the opportunity to manufacture our products at ACO's own production facilities located in 15 countries, often even close to the end user in order to offer the most competitive price.

A team of highly qualified specialists in Denmark constantly works on the development and optimization of our products, before they are released for production in different parts of the world.



ENG



DENMARK - HQ

Kirkevænget 5
7400 Herning
T. +45 97119600
acofunki@acofunki.dk
www.acofunki.dk

GERMANY

Am Ahlmannkai
24782 Büdelsdorf
T. +49 43316649711
F. +49 43314378912
www.acofunki.de

SPAIN

Cr. Major 52, 1r 1a
E-08110 Montcada
i Reixac (Barcelona)
T. +34 935 650727
www.acofunki.es

FRANCE

Parc d'innovation
de Mescoat
F-29800 Landerneau
T. +33 298 303685
www.acofunki.fr

CHINA

亚科畜牧养殖设备（青
岛）有限公司
山东省青岛市即墨区华
山二路615号
T. + 86 21 57749818-400
www.acofunki.cn